



5-DVD Changer Home Theater System OWNER'S MANUAL

MODEL: LH-E9674
(Main Unit: LH-E9674
Speakers: LHS-96PAF/LHS-96PAC/
LHS-96PAS/LHS-96PAW)



Before connecting, operating or repairing this product,
please read this instruction booklet carefully and
completely.



FOR THE WARRANTY TERMS & CONDITIONS,
PLEASE REFER TO BACK COVER OF THIS MANUAL.



CAUTION: TO REDUCE THE RISK OF ELECTRIC SHOCK DO NOT REMOVE COVER (OR BACK) NO USER-SERVICEABLE PARTS INSIDE REFER SERVICING TO QUALIFIED SERVICE PERSONNEL.



This lightning flash with arrowhead symbol within an equilateral triangle is intended to alert the user to the presence of uninsulated dangerous voltage within the product's enclosure that may be of sufficient magnitude to constitute a risk of electric shock to persons.



The exclamation point within an equilateral triangle is intended to alert the user to the presence of important operating and maintenance (servicing) instructions in the literature accompanying the product.

WARNING: TO REDUCE THE RISK OF FIRE OR ELECTRIC SHOCK, DO NOT EXPOSE THIS APPARATUS TO RAIN OR MOISTURE.

CAUTION: TO PREVENT ELECTRIC SHOCK, MATCH WIDE BLADE OF PLUG TO WIDE SLOT, FULLY INSERT.
ATTENTION: POUR ÉVITER LES CHOC ÉLECTRIQUES, INTRODUIRE LA LAME LA PLUS LARGE DE LA FICHE DANS LA BORNE CORRESPONDANTE DE LA PRISE ET POUSSER JUSQU'AU FOND.

WARNING: Do not install this equipment in a confined space such as a bookcase or similar unit.

NOTE TO CABLE/TV INSTALLER: This reminder is provided to call the cable TV system installer's attention to Article 820-40 of the National Electric Code (U.S.A.). The code provides guidelines for proper grounding and, in particular, specifies that the cable ground shall be connected to the grounding system of the building, as close to the point of the cable entry as practical.

CAUTION:

This unit employs a Laser System.

To ensure proper use of this product, please read this owner's manual carefully and retain for future reference. Should the unit require maintenance, contact an authorized service location.

Use of controls, adjustments, or the performance of procedures other than those specified herein may result in hazardous radiation exposure.

To prevent direct exposure to laser beam, do not try to open the enclosure. Visible laser radiation when open. DO NOT STARE INTO BEAM.

CAUTION: The apparatus should not be exposed to water (dripping or splashing) and no objects filled with liquids, such as vases, should be placed on the apparatus.

FCC WARNING: This equipment may generate or use radio frequency energy. Changes or modifications to this equipment may cause harmful interference unless the modifications are expressly approved in the instruction manual. The user could lose the authority to operate this equipment if an unauthorized change or modification is made.

REGULATORY INFORMATION: FCC Part 15

This equipment has been tested and found to comply with the limits for a Class B digital device, pursuant to Part 15 of the FCC Rules. These limits are designed to provide reasonable protection against harmful interference when the product is operated in a residential installation. This product generates, uses, and can radiate radio frequency energy and, if not installed and used in accordance with the instruction manual, may cause harmful interference to radio communications. However, there is no guarantee that interference will not occur in a particular installation. If this product does cause harmful interference to radio or television reception, which can be determined by turning the product off and on, the user is encouraged to try to correct the interference by one or more of the following measures:

- Reorient or relocate the receiving antenna.
- Increase the separation between the product and receiver.
- Connect the product into an outlet on a circuit different from that to which the receiver is connected.
- Consult the dealer or an experienced radio/TV technician for help.

SERIAL NUMBER: The serial number is found on the back of this unit. This number is unique to this unit and not available to others. You should record requested information here and retain this guide as a permanent record of your purchase.

Model No. _____

Serial No. _____

CAUTION concerning the Power Cord

Most appliances recommend they be placed upon a dedicated circuit;

That is, a single outlet circuit which powers only that appliance and has no additional outlets or branch circuits. Check the specification page of this owner's manual to be certain.

Do not overload wall outlets. Overloaded wall outlets, loose or damaged wall outlets, extension cords, frayed power cords, or damaged or cracked wire insulation are dangerous. Any of these conditions could result in electric shock or fire. Periodically examine the cord of your appliance, and if its appearance indicates damage or deterioration, unplug it, discontinue use of the appliance, and have the cord replaced with an exact replacement part by an authorized servicer.

Protect the power cord from physical or mechanical abuse, such as being twisted, kinked, pinched, closed in a door, or walked upon. Pay particular attention to plugs, wall outlets, and the point where the cord exits the appliance.

To disconnect power from the mains, pull out the mains cord plug. When installing the product, ensure that the plug is easily accessible.

IMPORTANT SAFETY INSTRUCTIONS

1. **Read these instructions.** - All these safety and operating instructions should be read before the product is operated.
2. **Keep these instructions.** - The safety, operating and use instructions should be retained for future reference.
3. **Heed all warnings.** - All warnings on the product and in the operating instructions should be adhered to.
4. **Follow all instructions.** - All operating and use instructions should be followed.
5. **Do not use this apparatus near water.** – For example: near a bath tub, wash bowl, kitchen sink, laundry tub, in a wet basement; or near a swimming pool; and other areas located near water.
6. **Clean only with dry cloth.** – Unplug this product from the wall outlet before cleaning. Do not use liquid cleaners.
7. **Do not block any ventilation openings. Install in accordance with the manufacturer's instructions.** - Slots and openings in the cabinet are provided for ventilation and to ensure reliable operation of the product and to protect it from over-heating. The openings should never be blocked by placing the product on a bed, sofa, rug or other similar surface. This product should not be placed in a built-in installation such as a bookcase or rack unless proper ventilation is provided or the manufacturer's instructions have been adhered to.
8. **Do not install near any heat sources such as radiators, heat registers, stoves, or other apparatus (including amplifiers) that produce heat.**
9. **Do not defeat the safety purpose of the polarized or grounding-type plug.** A polarized plug has two blades with one wider than the other. A grounding type plug has two blades and a third grounding prong. The wide blade or the third prong are provided for your safety. If the provided plug does not fit into your outlet, consult an electrician for replacement of the obsolete outlet.
10. **Protect the power cord from being walked on or pinched particularly at plugs, convenience receptacles, and the point where they exit from the apparatus.**
11. **Only use attachments/accessories specified by the manufacturer.**
12. **Use only with the cart, stand, tripod, bracket, or table specified by the manufacturer, or sold with apparatus. When a cart is used, use caution when moving the cart/apparatus combination to avoid injury from tip-over.**
13. **Unplug this apparatus during lightning storms or when unused for long periods of time.**
14. **Refer all servicing to qualified service personnel. Servicing is required when the apparatus has been damaged in any way, such as power-supply cord or plug is damaged, liquid has been spilled or objects have fallen into the apparatus, the apparatus has been exposed to rain or moisture, does not operate normally, or has been dropped.**



Contents

Introduction

IMPORTANT SAFETY INSTRUCTIONS	3
Contents	4
Symbol Used in this Manual	5
About the  Symbol Display	5
Notes on Discs	5
Types of Playable Discs	6
Disc-related terms	7
Front Panel	8
Display Window	9
Remote Control	10
Rear Panel	11

Installation and Setup

Setting up the unit	12
The unit Connections	12
Audio Connection to Optional Equipment	13
Antenna Connections	14
HDMI Connection	15
Assembling and Connecting to the Speakers	16
Speaker System Connection	16
Speaker Positioning	17
Selecting the Input/Output Source	18
Mini Glossary for Audio Stream & Surround Mode	19
Sound Mode	19
VIRTUAL sound	19
XTS/XTS pro	20
Displaying Disc Information on-screen	20
Initial Settings	20
General Operation	20
Language	21
Display	21
Audio	22
5.1 Speaker Setup	22
Lock (Parental Control)	23
Others	23

Operation

General features	24
Playback Setup	25
To open all discs	25
To select a playback disc	25
To play all discs on the disc trays	25
Special DVD Features	25
Checking the contents of DVD discs: Menus	25
Camera Angle	25
Additional features	26
Time Search	26
Marker Search	26
Last Scene Memory	26
Sleep Timer Setting	26
Dimmer	26
Mute	26
Using Headphone Jack	26
Playing an Audio CD or MP3/WMA file	27
Programmed Playback	27
Viewing a JPEG file	28
Playing a DivX Movie file	29
DVD Audio Discs	30
Presetting the Radio Stations	31
Listening to the Radio	31
XM Satellite Radio Operation	32
What is XM Satellite Radio?	32
What is XM Ready?	32
XM Satellite Radio connections	32
Activating Your Service	32
Selecting the XM Satellite Radio	32
XM information	32
Presetting the XM Satellite Radio Stations	33
Channel Selection	33
Advisory Message	33
Controlling your TV with the Supplied Remote Control	34-35
Controlling other TVs with the Supplied Remote Control	34

Reference

Language Codes	36
Area Codes	36
Troubleshooting	37-38
Maintenance and Service	38
Handling the Unit	38
Specifications	39

Introduction

To ensure proper use of this product, please read this owner's manual carefully and retain for future reference.

This manual provides information on the operation and maintenance of your unit. Should the unit require service, contact an authorized service location.

Symbol Used in this Manual

The lightning flash symbol alerts you to the presence of dangerous voltage within the product enclosure that may constitute a risk of electric shock.



The exclamation point alerts you to the presence of important operating and maintenance / servicing instructions.



Indicates hazards likely to cause harm to the unit itself or other material damage.





Note:

Indicates special notes and operating features.

Tip:

Indicates tips and hints for making the task easier.

A section whose title has one of the following symbols is applicable only to the disc represented by the symbol.

-  DVD and finalized DVD±R/RW
-  Audio CDs
-  MP3 Discs
-  WMA Discs
-  JPEG Discs

About the Symbol Display

“” may appear on your TV display during operation and indicates that the function explained in this owner's manual is not available on that specific DVD video disc.

Notes on Discs

HANDLING DISCS

Do not touch the playback side of the disc. Hold the disc by the edges so that fingerprints do not get on the surface. Never stick paper or tape on the disc.

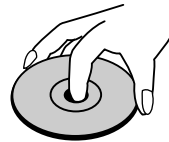

STORING DISCS

After playing, store the disc in its case. Do not expose the disc to direct sunlight or sources of heat and never leave it in a parked car exposed to direct sunlight.

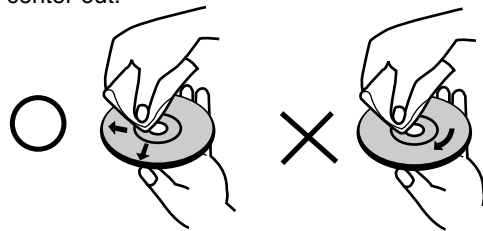

CLEANING DISCS

Fingerprints and dust on the disc can cause poor picture quality and sound distortion. Before playing, clean the disc with a clean cloth. Wipe the disc from the center out.



Do not use strong solvents such as alcohol, benzene, thinner, commercially available cleaners, or anti-static spray intended for older vinyl records.

Types of Playable Discs

	DVD (8 cm / 12 cm disc)
	Audio CD (8 cm / 12 cm disc)

In addition, this unit plays DVD \pm R, DVD +RW, DVD -RW(video mode) and CD \pm R / CD \pm RW that contains audio titles, MP3, WMA, and/or JPEG files.

Notes:

- Depending on the conditions of the recording equipment or the CD-R/RW (or DVD -R, DVD -RW) disc itself, some CD-R/RW (or DVD -R, DVD -RW) discs cannot be played on the unit.
- Do not attach any seal or label to either side (the labeled side or the recorded side) of a disc.
- Do not use irregularly shaped CDs (e.g., heart-shaped or octagonal) since they may result in malfunctions.

Notes on DVDs

Some playback operations of DVDs may be intentionally programmed by software manufacturers. This unit plays DVDs according to disc content designed by the software manufacturer, therefore some playback features may not be available or other functions may be added.

Manufactured under license from Dolby Laboratories. "Dolby", "Pro Logic", and the double-D symbol are trademarks of Dolby Laboratories. Confidential Unpublished works. Copyright 1992-1997 Dolby Laboratories. All rights reserved.
Manufactured under license from Digital Theater Systems, Inc. US Pat. No's. 5,451,942; 5,956,674; 5,974,380; 5,978,762; 6,487,535 and other US and world-wide patents issued and pending. "DTS" and "DTS Digital Surround" are registered trademarks of Digital Theater Systems, Inc. Copyright 1996, 2003 Digital Theater Systems, Inc. All rights reserved.

Note on DTS-encoded CDs

When playing DTS-encoded CDs, excessive noise may be exhibited from the analog stereo output. To avoid possible damage to the audio system, turn down the volume before playing back such discs, adjust the volume gradually, and keep the volume level low. To enjoy DTS Digital Surround[®] playback, an external 5.1 channel DTS Digital Surround[®] decoder system must be connected to the digital output of the unit.

Regional code

This unit is designed and manufactured for playback of region "1" encoded DVD software. This unit can play only DVD discs labeled "1" or "ALL".



Notes on Regional Codes

- Most DVD discs have a globe with one or more numbers in it clearly visible on the cover. This number must match your unit's regional code or the disc cannot play.
- If you try to play a DVD with a different region code from your player, the message "Check Regional Code" appears on the TV screen.

Notes on copyright

The unauthorized recording, use, distribution, or revision of television programs, videotapes, DVDs and other materials, is prohibited under the Copyright Laws of the United States and other countries, and may subject you to civil and/or criminal liability.

Disc-related terms

MP3

MP3 is a popular compression format used for digital audio files that yields very high near-CD quality.

WMA

Windows Media® audio file. A type of coding / decoding developed by Microsoft Corp.

JPEG

Joint Pictures Expert Group. JPEG is a compressed file format that allows you to save images with no limit on the number of colors.

Note on Windows Media

Windows Media is either a registered trademark or trademark of Microsoft Corporation in the United States and/or other countries.

Title (DVD video discs only)

A title is generally a distinct section of a DVD disc. For example the main feature could be title 1, a documentary describing how the film was made could be title 2, and cast interviews could be title 3. Each title is assigned a reference number enabling you to locate it easily.

Chapter (DVD video discs only)

A chapter is a segment of a title such as a scene in a film or one interview in a series. Each chapter is assigned a chapter number, enabling you to locate the chapter you want. Depending on the disc, chapters may not be recorded.

Track

A distinct element of audiovisual information, such as the picture or sound track for a specific language (DVD), or a musical piece on audio CD. Each track is assigned a track number, enabling you to locate the track you want. DVD discs allow one track of video (with multiple angles) and several tracks of audio.

Remote Control Operation Range

Point the Remote Control at the remote sensor and press the buttons.

- **Distance:** About 7m (23ft) from the front of the remote sensor
- **Angle:** About 30° in each direction of the front of the remote sensor

Remote Control battery installation

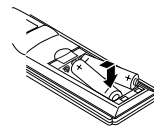

Detach the battery cover on the rear of the Remote Control, and insert two R03 (size AAA) batteries with **+** and **-** aligned correctly.

Caution

Never throw batteries into a fire.

Notes:

- Be sure to use AAA size batteries.
- Dispose of batteries in a designated disposal area.
- Batteries should always be disposed of with the environment in mind. Always dispose of batteries in accordance with applicable laws and regulations.
- If the Remote Control does not operate correctly, or if the operating range becomes reduced, replace batteries with new ones.
- When necessary to replace batteries in the Remote Control, always replace both batteries with new ones. Never mix battery types or use new and used batteries in combination.
- Always remove batteries from Remote Control if they are dead or if the Remote Control is not to be used for an extended period of time. This will prevent battery acid from leaking into the battery compartment.

Front Panel

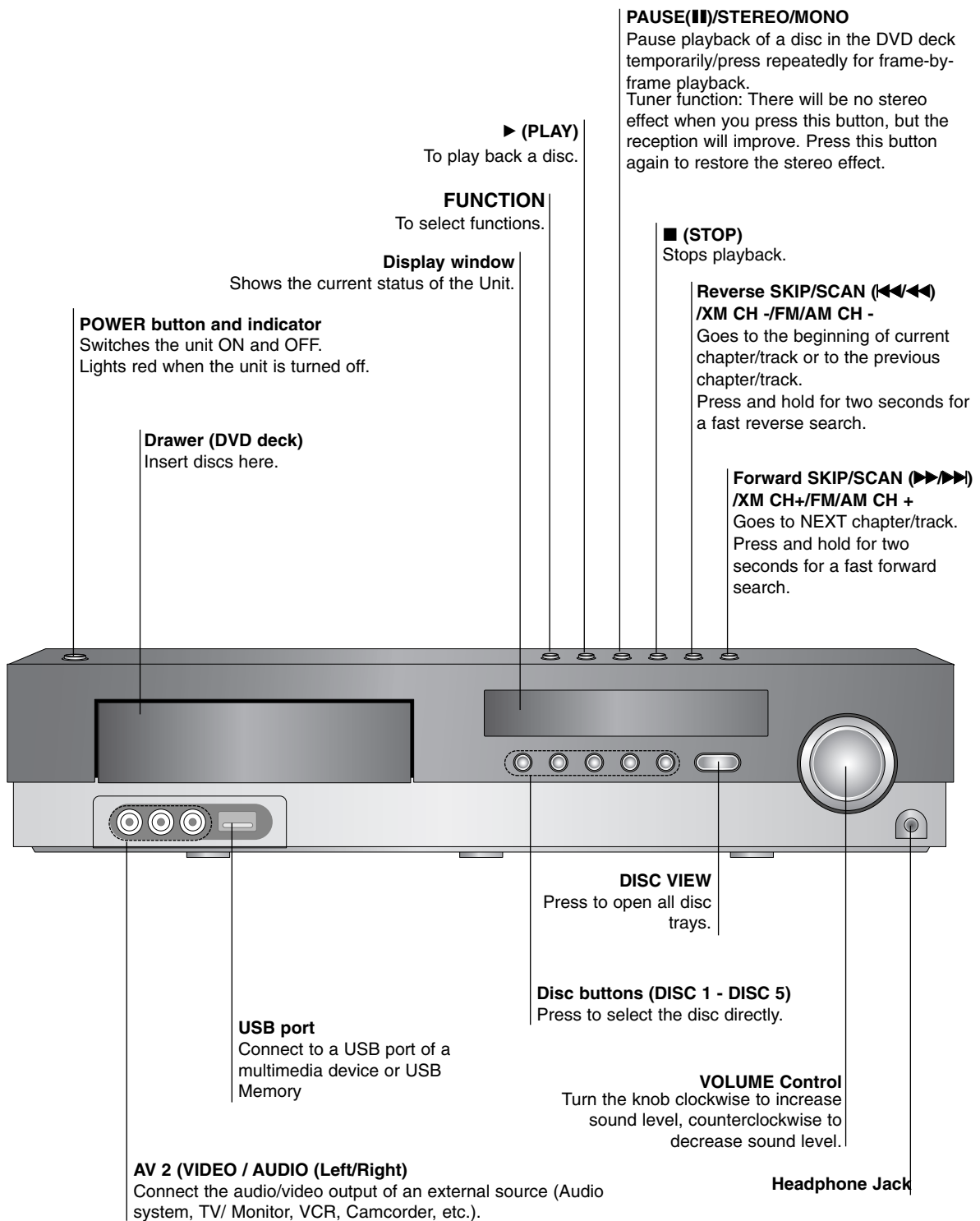

Display Window

DISC INDICATORS

Flashes when a disc is loaded in the disc tray.

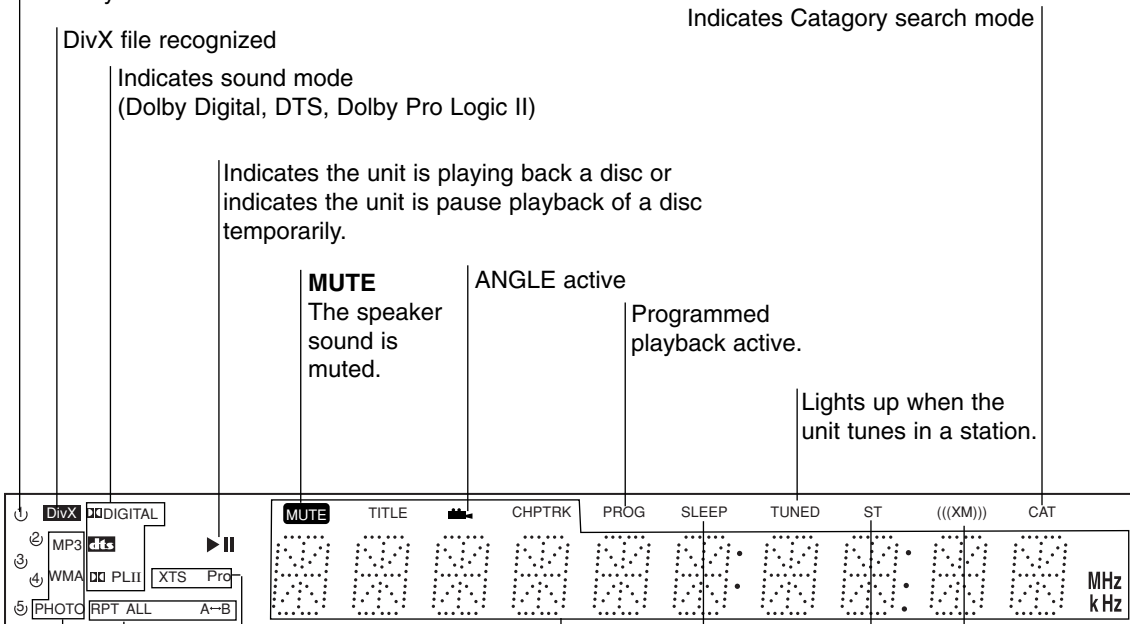

DivX file recognized

Indicates Category search mode

Indicates sound mode (Dolby Digital, DTS, Dolby Pro Logic II)

Indicates the unit is playing back a disc or indicates the unit is pause playback of a disc temporarily.

MUTE
The speaker sound is muted.

ANGLE active

Programmed playback active.

Lights up when the unit tunes in a station.

Indicates sound mode is XTS/XTS Pro

Repeat playback mode indicators.

MP3 MP3 disc inserted.
WMA WMA disc inserted.
PHOTO PHOTO disc inserted.

Lights up when the unit is receiving XM signal.

Lights up when a stereo broadcast is being received.

SLEEP timer indication

Indicates clock, total playing time, elapsed time, remaining time, title number, chapter/track number, radio frequency, volume, Surround mode or current deck status (Playback, Pause, etc).

Remote Control

- POWER**
Turns unit ON and OFF.
- DVD**
Select the unit's function mode to DVD.
- BAND**
Select FM, AM, XM band as the listening choice. (FM, AM and XM bands).
- AUX**
Selects external input source. (AV1 or AV2)
- USB**
Selects the USB port input source.
- Disc buttons (1-5)**
- XTS pro**
To select a specific disc
XTS: To enjoy more natural and realistic sound.
XTS pro: To enjoy great sound effect.
- MARKER**
Marks a point during playback.
- SEARCH**
Displays MARKER SEARCH menu.
- SETUP**
Accesses or removes Setup menu.
- MENU**
Accesses the menu on a DVD disc.
- STOP (■)**
Stops playback.
- PLAY (▶)**
Starts playback.
- PAUSE/STEP (⏸)**
Pause playback temporarily.
- SKIP (◀◀)**
- Skip to beginning of current DVD/CD chapter or track, press twice in quick succession to go to previous DVD/CD chapter or track.
- Press and hold for a fast reverse picture search in DVD mode.
- SCAN (◀◀)**
For fast reverse picture search.
- Reverse slow playback in pause mode.
- + SCAN (▶▶)**
For fast forward picture search.
- Forward slow playback in pause mode.
- + SKIP (▶▶)**
- Skip to next DVD/CD chapter or track.
- Press and hold for a fast forward picture search in DVD mode.
- REPEAT**
Repeat chapter, track, title or all.
- REPEAT A-B**
Repeats sequence between two points (A and B)
- RETURN**
Removes the setup menu.

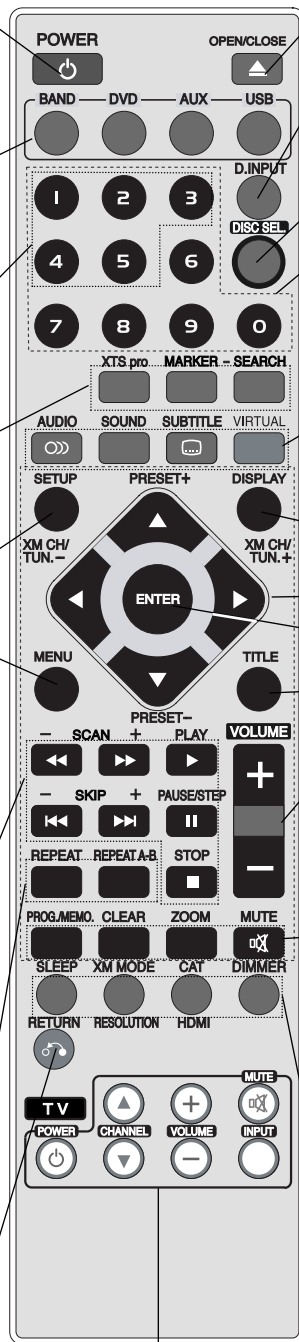

- OPEN/CLOSE**
Opens and closes all disc trays.
- D.INPUT**
To listen to an audio source connected to the DIGITAL AUDIO IN (OPTICAL or COAXIAL) jack with video from AV1 IN or AV2 IN .
- DISC SEL.**
To select a desired disc.
- 0-9 numerical buttons**
Selects numbered options in a menu.
- AUDIO**
Selects an audio language (DVD) or an audio channel (CD).
- SOUND**
Selects sound mode.
- SUBTITLE**
Selects a subtitle language.
- VIRTUAL**
Selects the QBS sound
- DISPLAY**
Accesses On-Screen display.
- ◀/▶/▲/▼ (left/right/up/down)**
Selects an option in the menu.
- ENTER**
Acknowledges menu selection.
- TITLE**
Displays the disc's Title menu, if available.
- VOLUME (+/-)**
Adjusts speaker sound level.
- PROG/MEMO.**
- Accesses or removes Program menu.
- Stores a radio station's frequency in the tuner's memory.
- CLEAR**
Removes a track number on the program menu or a mark on the MARKER SEARCH menu.
- ZOOM**
Enlarges DVD video image.
- MUTE**
Turns the sound on and off temporarily.
- SLEEP**
Set the System to turn off automatically at a specified time.
- XM MODE**
Selects a XM display mode
- RESOLUTION**
Changes the resolution.
- CAT**
Select the Category Search
- HDMI**
Turns the HDMI output On or Off
- DIMMER**
Press to change brightness of the display window on the front panel during power-on status.

TV Control Buttons

- **POWER:** Switches TV ON and OFF.
- **CHANNEL ▲/▼:** Selects TV's channel.
- **VOLUME +/-:** Adjusts TV's volume.
- **INPUT:** Selects the TV's source.
- **MUTE:** Turns the sound on and off temporarily.

Rear Panel

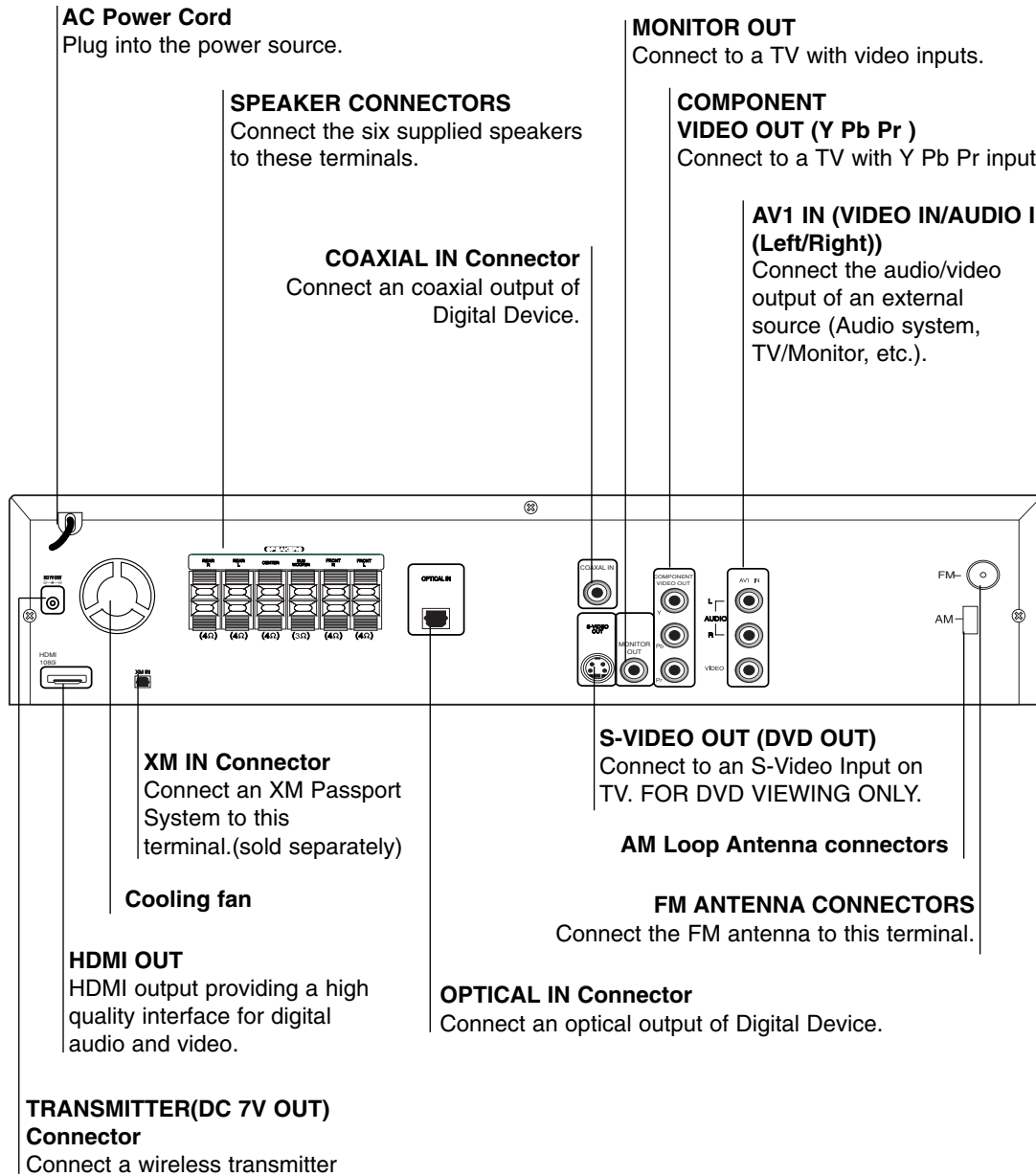

Do not touch the inner pins of the jacks on the rear panel. Electrostatic discharge may cause permanent damage to the unit.

Note:

Wireless XM transmitter and receiver is not supplied and must be purchased separately.

Installation and Setup

Setting up the unit

The picture and sound of a nearby TV, VCR, or radio may be distorted during playback. If this occurs, position the unit away from the TV, VCR, or radio, or turn off the unit after removing the disc.

The unit Connections

Depending on your TV and other equipment there are various ways you can connect the unit. Please refer to the manuals of your TV, stereo system or other devices as necessary for additional connection information.

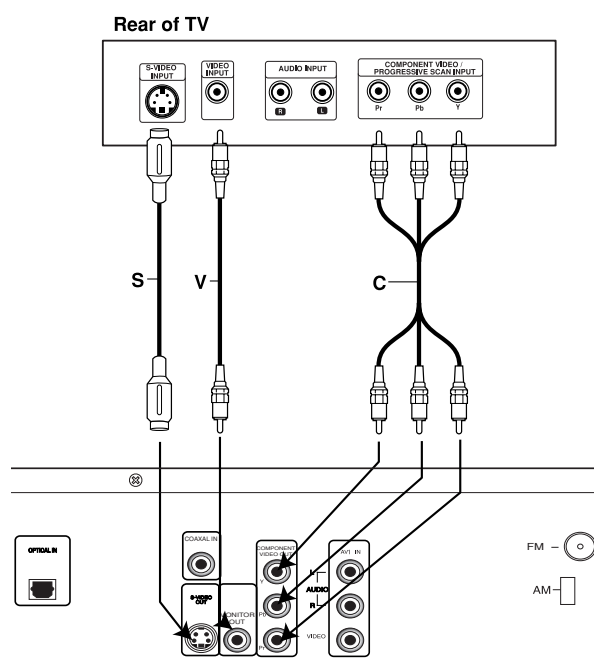

Video Connections to Your TV

Make sure the unit is connected directly to the TV and not to a VCR, otherwise the DVD image could be distorted by the copy protection system.

Video: Connect the MONITOR OUT jack on the unit to the video in jack on the TV using the video cable (V).

S-Video: Connect the S-VIDEO OUT jack on the unit to the S-Video in jack on the TV using the S-Video cable (S).

Notes:

- For MONITOR OUT and S-VIDEO OUT jack connection, resolution must be set to 480i or 480p by pressing RESOLUTION on the Remote Control, however MONITOR OUT and S-VIDEO OUT is always at 480i standard resolution.
- HDMI mode must be set to OFF for VIDEO OUT and S-VIDEO OUT jack connection.

Component Video (ColorStream®): Connect the COMPONENT VIDEO OUT jacks on the unit to the corresponding in jacks on the TV using an Y Pb Pr cable (C).

Progressive Scan (ColorStream Pro®):

- If your television is a high-definition or "digital ready" television, you may take advantage of the unit's progressive scan output for the highest video resolution possible.
- If your TV does not accept the Progressive Scan format, the picture will appear scrambled if you try Progressive Scan on the unit.

Notes:

- You can change the resolution (480i, 480p, 720p, 1080i) for the COMPONENT VIDEO OUT by pressing RESOLUTION on the Remote Control.
- For 720p and 1080i resolution, only non-copy protected discs can be played back. If the disc is copy protected, it will be displayed at the 480p resolution.
The resolution (720p, 1080i) is for the component and HDMI outputs only.
- HDMI mode must be set to OFF for Component video connections.
- The resolution (720p, 1080i) does not work with the analog video connections (VIDEO OUT & S-VIDEO).

Audio Connection to Optional Equipment

Connect the unit to your optional equipment for audio output.

1. Connect a VCR to the AV1 IN connectors (rear).
2. Connect an additional VCR to the AV2 IN connectors (front).
3. Connect an optical output of unit (or Digital Device etc) to the OPTICAL IN connector.
4. Connect an coaxial output of unit (or Digital Device etc) to the COAXIAL IN connector.
5. Connect the USB port of a USB Memory (or MP3 player, etc.) to the USB port on the front of the unit.

Note:

If the audio format of the digital output does not match the capabilities of your unit, the receiver will produce a strong, distorted sound or no sound at all.

To Remove the USB device from the unit

1. Choose a different function mode or press the STOP (■) twice in a row.
2. Remove the USB device from the unit.

Notes:

- Don't extract the USB device during operation.
- Music files (MP3/WMA), image files (JPEG) and DivX files can be played.
- This unit can not use a USB HUB.
- Recommended Memory Cards
Compact Flash Card (CFC), Micro Drive (MD), Smart Media Card (SMC), Memory Stick (MS), Secure Digital Card (SD), Multi Media Card (MMC), Memory Stick Pro (MS-Pro)
- Compatible with : FAT16, FAT 32
- Only use the memory cards recommended.
- Devices which require additional program installation when you have connected the unit to a computer are not supported.
- In case of a USB HDD, make sure to connect an auxiliary power cord to the USB HDD for proper operation. Up to four primary partitions of drive are supported. Extension partitions are not supported.
- If the drive of USB device is two or more, a drive folder is displayed on the screen. If you want to move to the initial menu after you select a folder, press RETURN.
- Digital cameras and mobile phones are not supported.

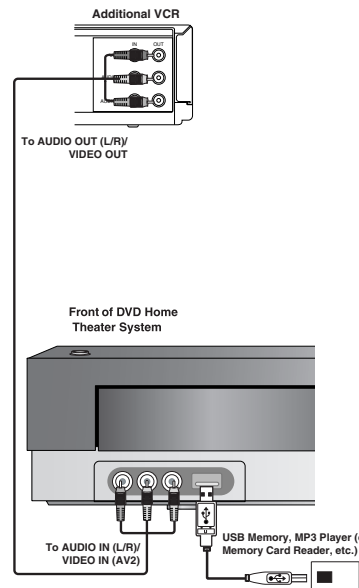
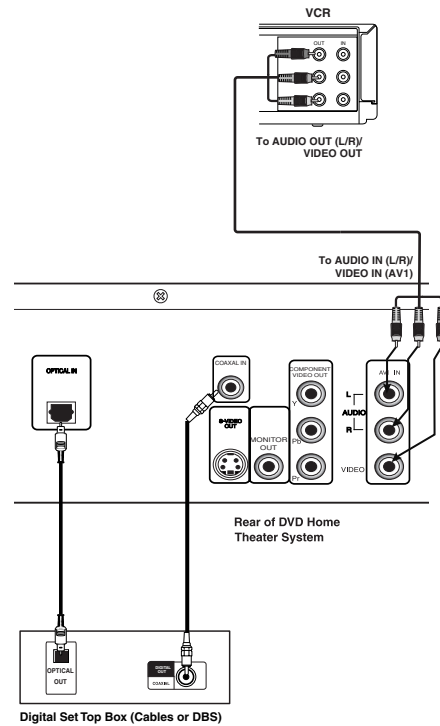

The unauthorized recording, use, distribution, or revision of television programs, videotapes, DVDs and other materials, is prohibited under the Copyright Laws of the United States and other countries, and may subject you to civil and/or criminal liability.

Antenna Connections

Connect the supplied BAND antenna for listening to the radio.

- Connect the FM Wire antenna to the FM antenna connector.
- Connect the AM Loop antenna to the AM antenna connector.

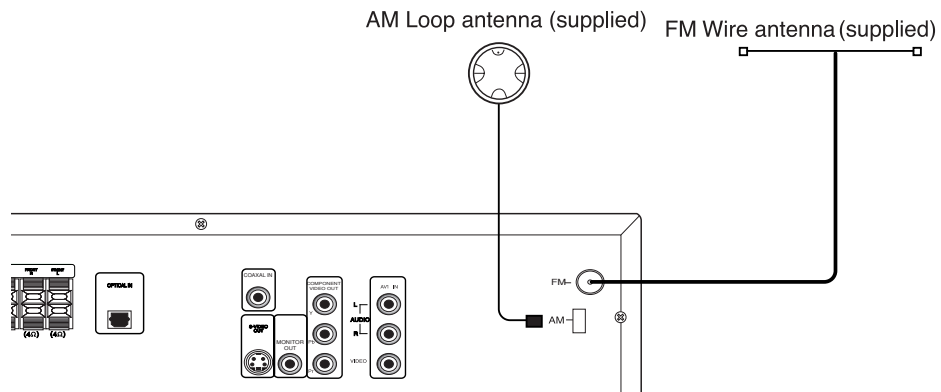

Notes:

- Be sure to fully extend the FM wire antenna.
- After connecting the FM Wire antenna, keep it as horizontal as possible.
- To prevent noise pickup, keep the AM Loop antenna away from the DVD/CD Receiver and other components.

HDMI Connection

If you have a HDMI TV or monitor, you can connect it to this unit using a HDMI cable.

1. Connect the HDMI OUT jack on the unit to the HDMI jack on a HDMI compatible TV or monitor (H).
2. Set the TV's source to HDMI (refer to TV's Owner's manual).
3. In stop mode, select HDMI mode by pressing HDMI. Press RESOLUTION repeatedly to select the resolution you wish to change.

Note:

- If HDMI cable is not connected, the HDMI button is not operated.
- The arrow on the cable connector body should face up for correct alignment with the connector on the unit.

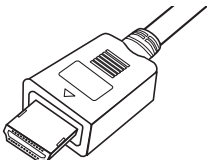

- If there is noise or lines on the screen, please check the HDMI cable.
- Not all HDCP-compatible DVI devices will work with this unit.
- If TV does not support HDCP, snow noise appears on the screen, or picture may be vibrated.

Tip :

When you use HDMI connection, you can change the resolution (480p, 720p, 1080i) for the HDMI output by pressing RESOLUTION on the Remote Control.

About HDMI

HDMI (High Definition Multimedia Interface) supports both video and audio on a single digital connection for an easy all- digital output to an HDMI or DVI-equipped TV.

Connection to an HDMI TV requires an HDMI cable while connection to a DVI-equipped TV requires an HDMI to DVI adaptor.

HDMI has the capability to support standard, enhanced, or high-definition video plus standard to multi-channel surround-sound audio, HDMI features include uncompressed digital video, a bandwidth of up to 5 gigabytes per second, one connector (instead of several cables and connectors), and communication between the AV source and AV devices such as DTVs.

HDMI, the HDMI logo and High-Definition Multimedia Interface are trademarks or registered trademarks of HDMI licensing LLC.

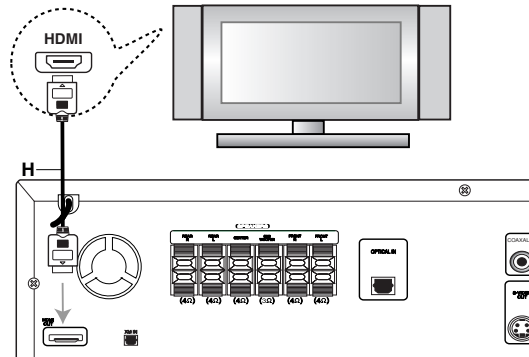

Resolution setting

You can change the resolution for the COMPONENT VIDEO OUT by pressing RESOLUTION on the Remote Control. Available resolution settings are as shown below.

OUTPUT CONNECTION	Available Resolution
HDMI VIDEO OUT	1920 x 1080i
	1280 x 720p
	720 x 480p
COMPONENT VIDEO OUT	1920 x 1080i
	1280 x 720p
	720 x 480p
	720 x 480i
MONITOR OUT	720 x 480i
S-VIDEO	720 x 480i

Notes:

- For 720p and 1080i resolution on the component video out, only non-copy protected discs can be played back. If the disc is copy protected, it will be displayed at the 480p resolution.
- 1080i and 720p does not work with the analog video connections (MONITOR OUT & S-VIDEO OUT).
- If you change the resolution, the display MENU (MP3/JPEG/DivX) size is changed.
- If your TV does not accept your resolution setting, abnormal pictures will appear on the screen. Please read TV's owner's manual then set the resolution that your TV can accept.

Assembling and Connecting to the Speakers

The front speakers are detached from the speaker stands. Connect the speaker cables and assemble the front speakers from speaker stands as illustrated.

1. Connect the speaker cables to the appropriate terminals on the bottom of each front speaker.
2. Attach the front speakers to the speaker stands by rotating the screw.

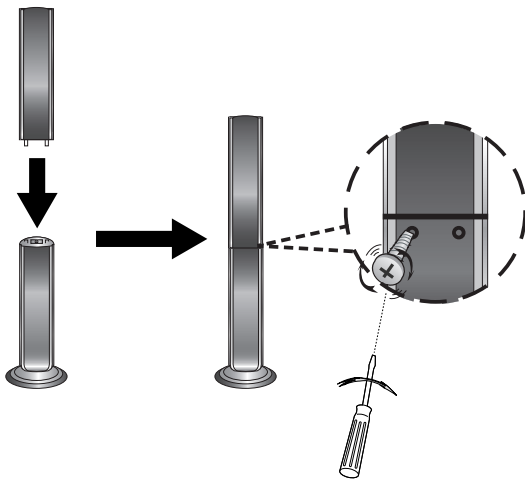

Speaker System Connection

Connect the speakers using the supplied speaker cables.

To obtain the best possible surround sound, adjust the speaker parameters (volume, distance, etc.).

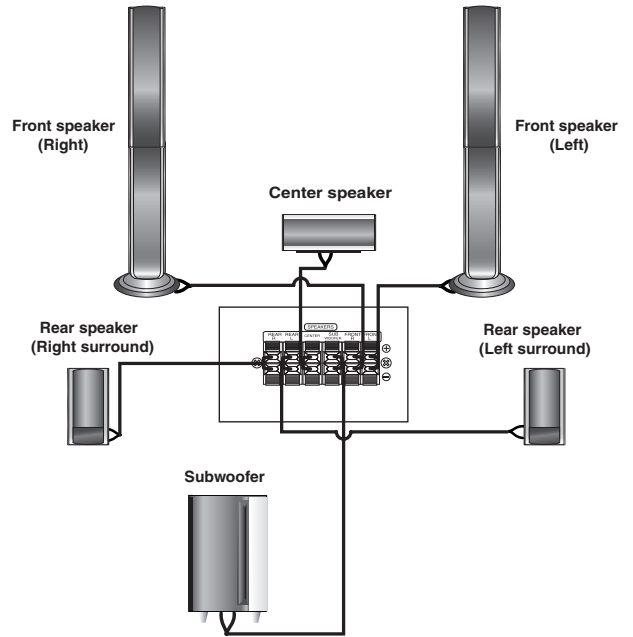

Notes:

- Be sure to match the speaker cable to the appropriate terminal on the components: + to + and - to -. If the cables are reversed, the sound will be distorted and will lack base.
- If you use front speakers with low maximum input rating, adjust the volume carefully to avoid excessive output on the speakers.

Speaker Positioning

In the case of normal position use the 6 speakers (2 front speakers, center speaker, 2 rear speakers and subwoofer).

If you want to play the excellent bass sound, DTS digital surround or Dolby Digital surround, you should connect a subwoofer.

- **Front speakers**

According to your listening position set up the speakers for equal distance. And by hearing position set up the interval between speakers to 45 degree.

- **Center speaker**

The center speaker and front speakers are ideally the same height. But normally place it above or below the television.

- **Rear speakers**

Place left and right behind the listening area. These speakers recreate sound motion and atmosphere required for surround sound playback. For best results, do not install the rear speakers too far behind the listening position and install them at or above the level of the listener's ears. It is also effective to direct the rear speakers towards a wall or ceiling to further disperse the sound.

In the case of a smaller room size, if the audience is near to the rear wall set the rear speakers opposite each other, and set the rear speakers above 60 - 90 cm than the listener's ears.

- **Subwoofer**

This can be placed in any front position.

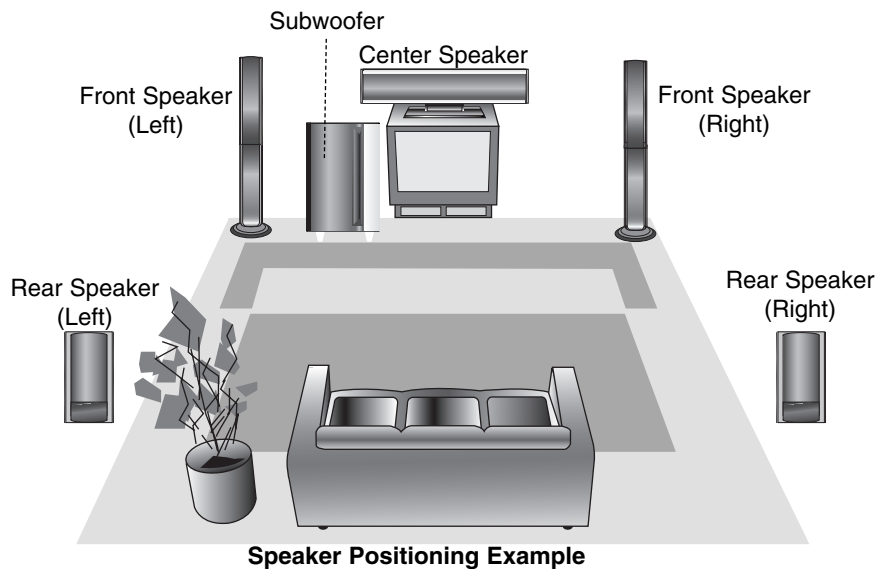

Selecting the Input/Output Source



Follow these guidelines to select and switch among the various unit input and output sources:

- **DVD/CD**

- To view output from the DVD deck:**

- Press DVD on the remote or FUNCTION on the front panel until the DVD indicator on the front panel lights and output from the DVD deck is viewed on the TV screen.

- **FM/AM/XM**

- To listen to FM/XM radio broadcasts:**

- Press BAND on the remote to toggle between FM, AM and XM radio. The selected frequency appears on the front panel display.

- **AUX**

- To view a source connected to the front or rear LINE inputs:**

- Press AUX to select AV IN (AV 1) (for rear panel) or LINE IN 2 (AV 2) (for front panel).

- **D.INPUT**

- To listen to an audio source connected to the DIGITAL AUDIO IN (OPTICAL or COAXIAL) jack with video from AV IN or LINE IN 2:**

- Press D.INPUT on the Remote Control once. AV 1 OPT or AV 2 OPT will appear on the front panel display. Audio will come from an external source connected to the DIGITAL AUDIO IN (OPTICAL) jack and video will come from an external source connected to the VIDEO IN jack of AV IN (for rear panel) or LINE IN 2 (AV 2) (for front panel).

- Press D.INPUT on the Remote Control twice. AV 1 COAX or AV 2 COAX will appear on the front panel display. Audio will come from an external source connected to the DIGITAL AUDIO IN (COAXIAL) jack and video will come from an external source connected to the VIDEO IN jack of AV IN (for rear panel) or LINE IN 2 (AV 2) (for front panel).

- To listen to an audio source connected to the AUDIO IN jack of AV IN or LINE IN 2 with video from AV IN or LINE IN 2 :**

- Press AUX on the Remote Control three times. AV 1 or AV 2 will appear on the front panel display. Audio will come from an external source connected to the AUDIO IN jacks of AV IN (for rear panel) or LINE IN 2 (AV 2) (for front panel) and video will come from an external source connected to the VIDEO IN jack of AV IN (for rear panel) or LINE IN 2 (AV 2) (for front panel).

Mini Glossary for Audio Stream & Surround Mode

☐ dts

Allows you to enjoy 5.1 (or 6) discrete channels of high quality digital audio from DTS program sources such as discs, DVD and compact discs, etc. bearing the trademark. DTS Digital Surround delivers up to 6 channels of transparent audio (which means identical to the original masters) and results in exceptional clarity throughout a true 360 degree sound field. "DTS" and DTS Digital Surround" are registered trademarks of Digital Theater Systems, Inc. Manufactured under license from Digital Theater Systems, Inc.

☐ DIGITAL

The Dolby Digital surround format lets you enjoy up to 5.1 channels of digital surround sound from a Dolby Digital program source. If you play DVDs with the "DOLBY DIGITAL" mark, you can enjoy even better sound quality, greater spatial accuracy, and improved dynamic range.

☐ PRO LOGIC

Use this mode when playing movie or Dolby Digital 2 channel which carries the "DOLBY DIGITAL" mark. This mode provides the effect of being in a movie theatre or live concert house—an effect with an intensity which can only be obtained through DOLBY PRO LOGIC SURROUND. The effect of the front/back/left/right movement of the sound image, as well as the sense of fixed position in the sound image, is much clearer and more dynamic than before.

☐ PRO LOGIC (II)

Dolby Pro Logic II creates five full-bandwidth output channels from two-channel sources. This is done using an advanced, high-purity matrix surround decoder that extracts the spatial properties of the original recording without adding any new sounds or tonal colorations.

MOVIE mode:

The Movie mode is for use with stereo television shows and all programs encoded in Dolby Surround. The result is enhanced soundfield directionality that approaches the quality of discrete 5.1-channel sound.

MUSIC mode:

The Music mode is for use with any stereo music recordings.

MATRIX mode:

The Matrix mode is the same as the Music mode except that the directional enhancement logic is turned off. It may be used to enhance mono signals by making them seem "larger." The Matrix mode may also find use in auto systems, where the fluctuations from poor FM stereo reception can otherwise cause disturbing surround signals from a logic decoder. The ultimate "cure" for poor FM stereo reception may be simply to force the audio to mono.

3D SURROUND

This unit can produce a 3D Surround effect, using 3D Surround Sound technology, which simulates multi-channel audio playback from two conventional stereo speakers instead of the five or more speakers normally required to listen to multi-channel audio from a home theatre. This feature works with DVD discs encoded with Dolby Pro Logic and Dolby Digital audio tracks.

BYPASS

Software with multichannel surround audio signals is played according to the way it was recorded.

Sound Mode

You can enjoy surround sound simply by selecting one of the pre-programmed sound fields according to the program you want to listen to.

Each time you press **SOUND** button, the sound mode is changed in the following order;

BYPASS → ON STAGE → STUDIO → CLUB → HALL → THEATER 1 → CHURCH → PL II MOVIE → PL II MUSIC → PL II MTRX → BYPASS...

(This function available 2-channel mode only)

When DVD is inserted.

You can change the audio mode of DVD (Dolby Digital, DTS, PRO LOGIC, etc) by pressing the **AUDIO** button on the remote

during playback. Although the DVD contents differ from disc to disc, the following explains the basic operation when this feature is used.

Each time you press **AUDIO** button, the audio mode of DVD is changed as the following order;

☐ DIGITAL → ☐ dts → ☐ PCM → ☐ DIGITAL



For your reference

- The unit memorizes the last mode settings for each source individually.
- You can identify the encoding format of program software by looking at its packaging.
 - Dolby Digital discs are labeled with the logo.
 - Dolby Surround encoded programs are labeled with the logo.
 - DTS Digital Surround discs are marked with DTS.

Note:

- Sound Mode is not applicable when headphone is used.
- Depending on the disc, some of the DVD audio mode may not be available.

Manufactured under license from Dolby Laboratories. "Dolby", "Pro Logic", and the double-D symbol are trademarks of Dolby Laboratories.

VIRTUAL sound

press **VIRTUAL** the setting VIRTUAL sound.

Source	Display	Effect
2.1 ch.	VIRTUAL	3D STEREO
5.1 ch	VIRTUAL	Multichannel sound

• 3D STEREO

Realtime 3D positioned sound rendering technology with stereo sources, optimized for stereo speakers. Listeners may experience amazing virtual surround effects with their own multimedia players.

• Multichannel sound

The Multichannel sound makes a 5.1 ch feel 10.1 ch sound therefore this mode provides a emotion which you are involved with sound and you can feel detailed sound.

XTS/XTS pro

Each time you press **XTS pro** the setting changes in the following order.

XTS ON → NORMAL → XTS-P ON...

- **XTS-P ON**
The unique sound quality of the LG Technology creates the optimum sound for you to play the perfect playback of the original sound and to feel the living sound source.
- **XTS ON**
When playing the movie with the weak bass sound relatively to the general music, it enforces the sense of sound at woofer for you to satisfy with. In the mode of 2 CH BYPASS, It creates the high display effect by playing the sound source via the rear speakers same as the front speakers.

Note:

The XTS mode is temporarily disabled when changing from 2.1 CH to 5.1 CH and it is enabled when changing it to 2.1 CH.

- **NORMAL**
XTS-P and XTS mode tune off

Displaying Disc Information on-screen

You can display various information about the disc loaded on-screen.

1. Press DISPLAY to show various playback information.
The items displayed differ depending on the disc type or playing status.
2. You can select an item by pressing ▲ / ▼ and change or select the setting by pressing ◀ / ▶.
 - Title (Track) – Current title (or track). number/total number of titles (or tracks).
 - Chapter – Current chapter number/total number of chapters.
 - Time – Elapsed playing time.
 - Audio – Selected audio language or channel.
 - Subtitle – Selected subtitle.
 - Angle – Selected angle/total number of angles.
 - Sound – Selected sound mode.

Note:

If no button is pressed for a few seconds, the on-screen display disappears.

Initial Settings

By using the Setup menu, you can make various adjustments to items such as picture and sound. You can also set a language for the subtitles and the Setup menu, among other things. For details on each Setup menu item, see pages 20 to 23

To display and exit the Menu:

Press SETUP to display the menu. A second press of SETUP will take you back to initial screen.

To go to the next level:

Press ▶ on the Remote Control.

To go back to the previous level:

Press ◀ on the Remote Control.

GENERAL OPERATION

1. Press SETUP. The Setup menu appears.
2. Use ▲ / ▼ to select the desired option then press ▶ to move to the second level. The screen shows the current setting for the selected item, as well as alternate setting(s).
3. Use ▲ / ▼ to select the second desired option then press ▶ to move to the third level.
4. Use ▲ / ▼ to select the desired setting then press ENTER to confirm your selection. Some items require additional steps.
5. Press SETUP or PLAY to exit the Setup menu.

LANGUAGE

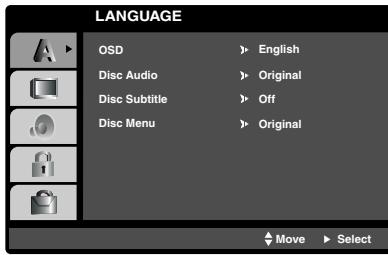

OSD

Select a language for the Setup menu and on-screen display.

Disc Audio / Subtitle / Menu

Select the language you prefer for the audio track (disc audio), subtitles, and the disc menu.

Original – Refers to the original language in which the disc was recorded.

Other – To select another language, press number buttons then ENTER to enter the corresponding 4-digit number according to the language code list on page 36. If you enter the wrong language code, press CLEAR.

DISPLAY

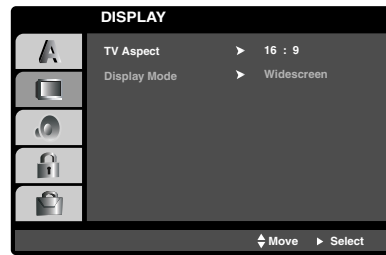

TV Aspect

4:3 – Select when a standard 4:3 TV is connected.

16:9 – Select when a 16:9 wide TV is connected.

Display Mode

Display Mode setting works only when the TV Aspect mode is set to “4:3”.

Letterbox – Displays a wide picture with bands on the upper and lower portions of the screen.

Panscan – Automatically displays the wide picture on the entire screen and cuts off the portions that do not fit.

AUDIO

Each DVD disc has a variety of audio output options. Set the receiver's AUDIO options according to the type of audio system you use.

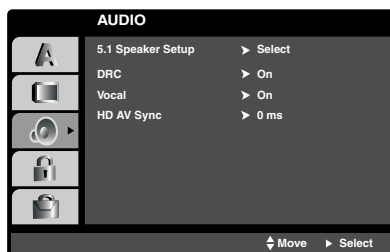

Dynamic Range Control (DRC)

With the DVD*1 format, you can hear a program's soundtrack in the most accurate and realistic presentation possible, thanks to digital audio technology. However, you may wish to compress the dynamic range of the audio output (the difference between the loudest sounds and the quietest ones). Then, you may listen to a movie at a lower volume without losing clarity of sound. Set DRC to On for this effect.

*1: Dolby Digital only

Vocal

Set Vocal to On only when a multi-channel karaoke DVD is playing. The karaoke channels on the disc will mix into normal stereo sound.

HD AV Sync

You can adjust delay time a Audio signal as contrasted with a Video signal in milli-seconds.

0 → 10 → 20 → ... → 300

5.1 Speaker Setup

Make the following settings for the built-in 5.1 channel surround decoder.

1. Press ENTER and 5.1 Speaker Setup menu appears.

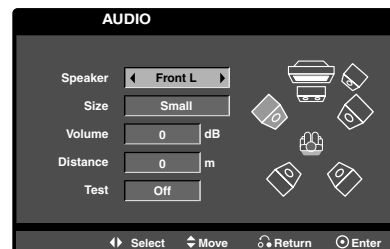

2. Use ◀ / ▶ to select the desired speaker.
3. Adjust options using ▲ / ▼ / ◀ / ▶ buttons.
4. Press ENTER to confirm your selection. Returns to the previous menu.

Speaker selection

Select a speaker that you want to adjust. (Front speakers (Left), Front speakers (Right), Center Speaker, SubWoofer, Rear speakers (Left), or Rear speakers (Right))

Note:

Certain speaker settings are prohibited by the Dolby Digital licensing agreement.

Size

Since the speaker settings are fixed, you cannot change the settings.

Volume

Press ◀ / ▶ to adjust the output level of the selected speaker. (-5dB ~ 5dB)

Distance

If you connected speakers to your unit, setting the Distance lets the speakers know how far the sound has to travel to reach your set listening point. This allows the sound from each speaker to reach the listener at the same time.

Press ◀ / ▶ to adjust the Distance of the selected speaker. (You can't adjust front / Woofer speakers)

Test

Press ◀ / ▶ to test the signals of each speaker. Adjust the volume to match the volume of test signals memorized in the system.

Front Left (L) → Center → Front Right (R) →
Rear Right (R) → Rear Left (L) → SubWoofer

LOCK (Parental Control)

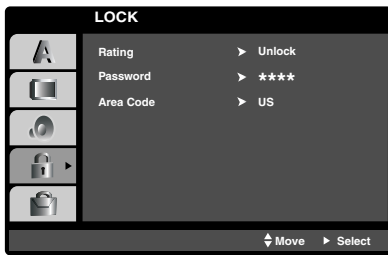

Rating

Blocks playback of rated DVDs based on their content. Not all discs are rated.

1. Select "Rating" on the LOCK menu then press ►.
2. To access the LOCK options, you must input the password you have created. If you have not yet entered password, you are prompted to do so. Input a password and press ENTER. Enter it again and press ENTER to verify. If you make a mistake before pressing ENTER, press CLEAR.
3. Select a rating from 1 to 8 using the ▲ / ▼ buttons.

Rating 1-8: Rating one (1) has the most restrictions and rating eight (8) is the least restrictive.

Unlock: If you select unlock, parental control is not active and the disc plays in full.

4. Press ENTER to confirm your rating selection, then press SETUP to exit the menu.

Password

You can enter or change password.

1. Select Password on the LOCK menu then press ►.
2. Follow step 2 as shown above (Rating). To change the password, press ENTER when the "Change" option is highlighted. Input a password and press ENTER. Press ENTER. Input a new password and press ENTER. Enter it again and press ENTER to verify.
3. Press SETUP to exit the menu.

If you forget your password

If you forget your password, you can clear it using the following steps:

1. Press SETUP to display the Setup menu.
2. Input the 6-digit number "210499" and press ENTER. The password is cleared.

Area Code

Enter the code of the area whose standards were used to rate the DVD video disc, based on the list on page 36.

1. Select "Area Code" on the LOCK menu then press ►.
2. Follow step 2 as shown previous paragraph (Rating).
3. Select the first character using ▲ / ▼ buttons.
4. Press ► and select the second character using ▲ / ▼ buttons.
5. Press ENTER to confirm your Area code selection.

OTHERS

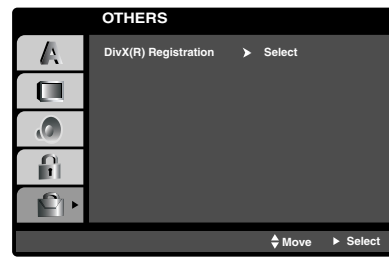

DivX(R) Registration

We provide you the DivX® VOD (Video On Demand) registration code that allows you to rent and purchase videos using the DivX® VOD service. For more information, visit www.divx.com/vod.























1. Select "DivX(R) Registration" option then press ►.
2. Press ENTER while "Select" is selected and the registration code will appear. Use the registration code to purchase or rent the videos from DivX® VOD service at www.divx.com/vod. Follow the instructions and download the video onto a disc for playback on this unit.
3. Press ENTER to exit.

Note:

All the downloaded videos from DivX® VOD can only be played back on this unit.

Operation

General features

Buttons	Operations	Discs
 (OPEN / CLOSE)	Opens or closes the disc tray.	ALL
 (PAUSE)	During playback, press  to pause playback. Press  repeatedly to play Frame-by-Frame.	ALL DVD DivX
SKIP ( / )	During playback, press SKIP ( or ) to go to the next chapter/track or to return to the beginning of the current chapter/track. Press SKIP  twice briefly to step back to the previous chapter/track.	ALL
SCAN ( / )	During playback, press SCAN ( or ) repeatedly to select the required scan speed. DVD : 5 steps (X2, X4, X8, X16, X100) DivX disc : 4 steps (X2, X4, X8, X16) WMA/MP3, Audio CD : 3 steps (X2, X4, X8)	DVD DivX ACD MP3 WMA
REPEAT	During playback, press REPEAT repeatedly to select a desired repeat mode. DVD Video discs: Chapter/Title/Off Audio CD, DivX/MP3/WMA discs: Track/All/Off	ALL
A-B	During playback, each press of A-B button to select point A and point B and repeats a sequence from point A (Starting point) to point B (End point). Press REPEAT A-B to exit.	DVD
ZOOM	During playback or pause mode, press ZOOM to enlarge the video image (3 steps). You can move through the zoomed picture using     buttons.	DVD
TITLE	If the current DVD title has a menu, the title menu appears on the screen. Otherwise, the disc menu may appear.	DVD
MENU	The disc menu appears on the screen.	DVD
 (SUBTITLE)	During playback, press SUBTITLE repeatedly to select a desired subtitle language.	DVD DivX
 (AUDIO language)	During playback, press AUDIO repeatedly to hear a different audio language or audio track.	DVD DivX
SLOW	Pause mode, press SCAN ( or ) to select the required speed. DVD :  (1/2, 1/4, 1/8, 1/16) or  (1/2, 1/4, 1/8, 1/16)	DVD

Playback Setup

Turn on the TV and select the video input source connected to the unit.

To open all discs

Press DISC VIEW on the unit or OPEN/CLOSE on the remotecontrol to open all disc trays in the drawer during stop.

“OPEN” will appear in the display window.

You can check a disc in the disc tray.

Notes:

If you press OPEN/CLOSE of the active disc tray, the disc tray will not slide out. Current disc is continuously playback.

To select a playback disc

Press DISC SEL. and press desired disc button (DISC 1-5) on the Remote Control.

Press desired disc button (DISC 1-5) on the unit.

Tip:

You can also use the disc number play buttons on the unit.

Notes:

- To ensure good system performance, wait until the disc tray completely read the disc(s) before proceeding.
- The unit is only able to read the status of the current selected disc tray.

To play all discs on the disc trays **CD**

Press PLAY(▶) on the Remote Control or on the unit.

All the available discs will play once.

Tip:

During playback, track number and elapsed playing time of the current track will appear in the display window.

Note:

- If on the disc trays have inserted only MP3 disc, WMA disc and Audio disc, all discs will repeat playback.
- This function is not available during Repeat playback or Programmed playback mode.
- If the discs that contain its own menu has inserted, you can not use this function properly.

Special DVD Features

Checking the contents of DVD discs: Menus

DVDs may offer menus that allow you to access special features. To use the disc menu, press MENU. Input the corresponding number or use the ◀ ▶ ▲ ▼ buttons to highlight your selection. Then press ENTER.

Camera Angle **DVD**

If the disc contains scenes recorded at different camera angles, you can change to a different camera angle during playback.

1. Press DISPLAY during playback.
2. Use ▲ or ▼ to select the angle option. The angle option will be highlighted.
3. Use ◀ or ▶ to to select angle.

Tip:

The angle indicator will appear on the front display during scenes recorded at different angles as an indication that angle switching is possible.

Notes on general features:

- If you press SKIP (▶▶) once during Repeat Chapter (Track) playback, the repeat playback cancels.
- Zoom may not work on some DVDs.
- The A-B repeat function is available only in the current title.

Additional features

Time Search **DVD** **DivX**

To start playing at any chosen time on the disc:

1. Press DISPLAY during playback.
2. Press ▲ / ▼ to select the time clock icon and "--:--:--" appears.
3. Input the required start time in hours, minutes, and seconds from left to right. If you enter the wrong numbers, press CLEAR to remove the numbers you entered. Then input the correct numbers.
4. Press ENTER to confirm. Playback starts from the selected time.

Marker Search **DVD** **DivX**

To enter a Marker

You can start playback from up to nine memorized points. To enter a marker, press MARKER at the desired point on the disc. The Marker icon appears on the TV screen briefly. Repeat to enter up to nine markers.

To Recall or Clear a Marked Scene

1. During disc playback, press SEARCH. The marker search menu appears on the screen.
2. Within 10 seconds, press ◀ / ▶ to select a marker number that you want to recall or clear.
3. Press ENTER and playback starts from the marked scene. Or, Press CLEAR and the marker number is erased from the list.
4. You can play any marker by inputting its number on the marker search menu.

Last Scene Memory

DVD

This receiver memorizes last scene from the last disc that is viewed. The last scene remains in memory even if you remove the disc from the receiver or switch off the receiver. If you load a disc that has the scene memorized, the scene is automatically recalled.

Note:

This receiver does not memorize the scene of a disc if you switch off the receiver before commencing to play the disc.

Sleep Timer Setting

You can set the unit to turn off automatically at a specified time.

1. Press SLEEP to set the desired sleep time.

The SLEEP indicator and sleep time appears in the display window.

2. Each time you press SLEEP the setting changes in the following order.

SLEEP 180 → 150 → 120 → 90 → 80 → 70 → 60 → 50 → 40 → 30 → 20 → 10 → OFF

Note:

- You can check the time remaining before the unit turns off.
Press SLEEP. The remaining time appears in the display window.

Dimmer

This function will change the brightness of the display window on the front panel during in power-on status. Press the DIMMER repeatedly.

Button's light turn off → Display window make din → Display window and Button's light are on

Mute

Press MUTE to mute your unit.

You can mute your unit in order, for example, to answer the telephone, "MUTE" indicator flashes in the display window.

Press MUTE again or adjust the volum to release it.

Using Headphone Jack

Connect a stereo headphone plug (∅3.5mm) into the PHONES connector.

The speakers are automatically disconnected when you plug in a headphone (not supplied).

The unit volume and headphone volume have to adjust separately..

Playing an Audio CD or MP3/WMA file

This unit can play Audio CDs or MP3/WMA files recorded media.

MP3/ WMA/ Audio CD

Once you insert an MP3/WMA files recorded media or Audio CD, a menu appears on the TV screen.

Press ▲ / ▼ to select a track/file then press PLAY or ENTER and playback starts. You can use variable playback functions. Refer to page 24.



Tips:

- Press MENU to move to the next page.
- On a CD with MP3/WMA and JPEG you can switch MP3/WMA and JPEG. Press TITLE and MUSIC or PHOTO word on top of the menu is highlighted.

MP3 / WMA disc compatibility with this player is limited as follows:

- Sampling frequency: within 32 - 48 kHz (MP3), within 24 - 48kHz (WMA)
- Bit rate: within 32 - 320kbps (MP3), 40 - 192kbps (WMA)
- The unit cannot read an MP3/WMA file that has a file extension other than “.mp3” / “.wma”.
- CD-R physical format should be ISO 9660
- If you record MP3 / WMA files using software that cannot create a file system (eg. Direct-CD) it is impossible to playback MP3 / WMA files. We recommend that you use Easy-CD Creator, which creates an ISO 9660 file system.
- File names should have a maximum of 8 letters and must incorporate an .mp3 or .wma extension.
- They should not contain special letters such as / ? * : “ < > | etc.
- The total number of files on the disc should be less than 999.

This unit requires discs and recordings to meet certain technical standards in order to achieve optimal playback quality. Pre-recorded DVDs are automatically set to these standards. There are many different types of recordable disc formats (including CD-R containing MP3 or WMA files) and these require certain pre-existing conditions (see above) to ensure compatible playback.

Customers should note that permission is required in order to download MP3 / WMA files and music from the Internet. Our company has no right to grant such permission. Permission should always be sought from the copyright owner.

Programmed Playback

The program function enables you to store your favorite tracks from any disc in the receiver memory. A program can contain 300 tracks.

1. Insert a disc.
Audio CD and MP3/WMA Discs:
2. Select a track on the “List”, then press PROG. or select “⏏ (Add)” icon then press ENTER to place the selected track on the “Program” list. Repeat to place additional tracks on the list.

Note:

You can add all tracks in the disc. Select “⏏ (Add All)” icon then press ENTER.

3. Select the track you want to start playing on the “Program” list. Press MENU to move to the next page.
4. Press PLAY or ENTER to start. Playback begins in the order in which you programmed the tracks. Playback stops after all of the tracks on the “Program” list have played once.
5. To resume normal playback from programmed playback, select a track of AUDIO CD (or MP3/WMA) list and then press PLAY.

Repeat Programmed Tracks

1. Press REPEAT when playing a disc. The repeat icon appears.
2. Press REPEAT to select a desired repeat mode.
 - TRACK: repeats the current track
 - ALL: repeats all the tracks on programmed list.
 - Off(No display): does not play repeatedly.

Erasing a Track from “Program” List

1. Use ▲ ▼ to select the track that you wish to erase from the Program list.
2. Press CLEAR. Alternatively, select “⏏ (Delete)” icon then press ENTER to place the selected track on the Program list. Repeat to erase additional tracks on the list.

Erasing the Complete Program List

Use ▲ / ▼ to select “⏏ (Del all)”, then press ENTER.

Note:

The programs are also cleared when the disc is removed or others disc was played.

Viewing a JPEG file **JPEG**

This unit can play discs with JPEG files.
Before playing JPEG recordings, read the notes on JPEG Recordings on right.

1. Insert a disc and close the tray.
The PHOTO menu appears on the TV screen.

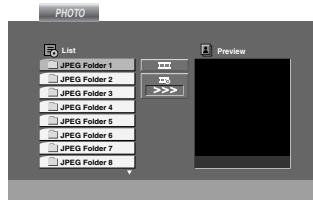

2. Press ▲ / ▼ to select a folder, and press ENTER. A list of files in the folder appears.
If you are in a file list and want to return to the previous Folder list, use the ▲ / ▼ buttons on the remote to highlight  and press ENTER.
3. If you want to view a particular file, press ▲ / ▼ to highlight a file and press ENTER or PLAY. While viewing a file, you can press STOP to move to the previous menu (JPEG menu).

Notes:

- When viewing a JPEG file, the resolution is changed 480p if the resolution set to 1080i. You can change the resolution for 720p or 480p.

Tips:

- There are four Slide Speed options  :
> (Slow), >> (Normal), >>> (Fast) and II (off).
Use ▲ / ▼ / ◀ / ▶ to highlight the Speed. Then, use ◀ / ▶ to select the option you want to use then press ENTER.
- If you set Speed option to Off, Slide is not active.

Slide Show

Use ▲ ▼ ◀ ▶ to highlight the  (Slide Show) then press ENTER. (You can not change resolution)

Still Picture

1. Press PAUSE/STEP during slide show.
The unit will now go into PAUSE mode.
2. To return to the slide show, press PLAY or press PAUSE/STEP again.

Moving to another File

Press SKIP (◀◀ or ▶▶) once while viewing a picture to advance to the next or previous file.

To rotate picture

Press ◀ / ▶ / ▲ / ▼ during showing a picture to rotate the picture clockwise or counter-clockwise.

JPEG disc compatibility with this player is limited as follows:

- Depending upon the size and number of JPEG files, it could take a long time for the unit to read the disc's contents. If you don't see an on-screen display after several minutes, some of the files may be too large — reduce the resolution of the JPEG files to less than 2M pixels as 2760 x 2048 pixels and burn another disc.
- The total number of files and folders on the disc should be less than 999.
- Some discs may be incompatible due to a different recording format or the condition of disc.
- Ensure that all the selected files have the “.jpg” extensions when copying into the CD layout.
- If the files have “.jpe” or “.jpeg” extensions, please rename them as “.jpg” file.
- File names without “.jpg” extension will not be able to be read by this unit. Even though the files are shown as JPEG image files in Windows Explorer.

Playing a DivX Movie file

Using this unit you can play DivX disc.

1. Insert a disc and close the tray. The MOVIE menu appears on the TV screen.

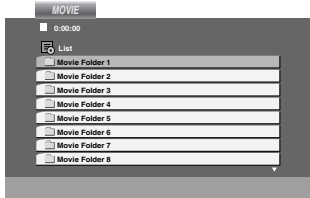

2. Press ▲ / ▼ to select a folder, and press ENTER. A list of files in the folder appears. If you are in a file list and want to return to the Folder list, use the ▲ / ▼ buttons on the remote to highlight  and press ENTER.
3. If you want to view a particular file, press ▲ / ▼ to highlight a file and press ENTER or PLAY.
4. Press STOP to exit.

Notice for displaying the Divx subtitle

If the subtitle does not display properly during playback, press and hold S-TITLE about 3 seconds then press S-TITLE to select another language code until the subtitle is displayed properly

Tips:

- Press MENU to move to the next page.
- On a CD with MP3/WMA, JPEG and MOVIE file, you can switch MUSIC, PHOTO and MOVIE menu. Press TITLE and MUSIC, PHOTO and MOVIE word on top of the menu is highlighted.
- You can select the desired title using the ◀ / ▶.

Notes:

- Be sure to select "SUBTITLE ON" mode by pressing the subtitle file every time before playing a DivX file .
- When the subtitle has more than two languages in the file, original subtitle is only available.
- The DivX files in your memory card can not be played.
- You can not adjust sound mode and VIRTUAL sound during the DivX file playing.

DivX disc compatibility with this player is limited as follows:

- Available resolution size of the DivX file is under 800x600 (W x H) pixel.
- The file name of the DivX subtitle is available by 45 characters.
- If there is impossible code to express in the DivX file, it may be displayed as " _ " mark on the display.
- **If the number of the screen frame is over 30 per 1 second, this unit may not operate normally.**
- **If the video and audio structure of recorded file is not interleaved, either video or audio is outputted.**

Playable DivX file

- ".avi ", ".mpg ", ".mpeg ", ".divx"

Playable Subtitle format

- SubRip(*.srt/*.txt)
- SAMI(*.smi)
- SubStation Alpha(*.ssa/*.txt)
- MicroDVD(*.sub/*.txt)
- SubViewer 2.0(*.sub/*.txt)
- VobSub(*.sub)

Playable Codec format

- "DIVX3.xx ", "DIVX4.xx ", "DIVX5.xx ", "XVID ", "MP43 ", "3IVX "

Playable Audio format

- "AC3 ", "DTS ", "PCM ", "MP3 ", "WMA "
- Sampling frequency: within 32 - 48 kHz (MP3), within 24 - 48kHz (WMA)
- Bit rate: within 32 - 320kbps (MP3), 40 - 192kbps (WMA)

DVD Audio Discs

DVD Audio is a new disc format building on the success of DVD to provide high quality, uncompressed, multi-channel audio for a new experience in audio quality. A DVD Audio disc can be identified by the DVD audio logo on the disc jacket or on the disc itself.

DVD Audio can provide higher quality stereo than Audio CDs with a sampling rate of up to 192kHz (compared to 44.1kHz for CDs). DVD Audio digital sound can be delivered with up to 24 bits of data (compared to 16 bits for a standard CD).

A typical DVD Audio disc contains up to seven times the data capacity of a CD. This additional space is used for music, either Advanced Resolution multi-channel sound quality that is closer to the artist's master recording or for longer recordings. Many DVD Audio discs contain on-screen text, such as artist biographies, playlists, or lyrics. Some DVD Audio discs contain photo galleries or video clips.

Note:

To enjoy maximum sound quality and surround effect of DVD Audio, you must use 5.1 channel analog audio output (5.1CH AUDIO OUT jacks on the unit).

Moving to another GROUP

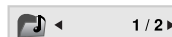

Some DVD Audio discs divide content into different groups. Your player enables you to quickly access different groups during playback via the on-screen display.

1. Press DISPLAY during playback on in stop mode.
2. Press ▲▼ to select Group icon.
3. Press ◀▶ or the numbered buttons (0-9) to select a group number.

Note:

Sometimes the author of the disc creates hidden content that can only be accessed by entering a password. If the lock icon appears on the TV screen, enter the password (sometimes you'll find it on the disc's jacket cover or on a web site). This password control isn't dictated by your unit — it is a function of the disc.

Since the authoring of DVD Audio Discs varies, some of the on-screen display choices might not be available for the disc you're playing.

Viewing another PAGE

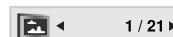

Since DVD Audio discs can hold a lot of content, there are various ways to see what's available on the disc.

1. Press DISPLAY during playback.
2. Press ▲▼ to select Page icon.
3. Press ◀▶ to select a page number.

What appears on the screen will vary from disc to disc because the information available depends upon the way the disc was created.

Note:

Since the authoring of DVD Audio Discs varies, some of the on-screen display choices might not be available for the disc you're playing.

Presetting the Radio Stations

You can preset 50 stations for FM and AM. Before tuning, make sure that you have turned down the volume.

1. Press BAND on the Remote Control until FM or AM appears in the display window.
2. Press and hold TUN.(-/+) for about two seconds until the frequency indication starts to change, then release.
Scanning stops when the unit tunes in a station.
3. Press PROG/MEMO on the Remote Control.
A preset number will flash in the display window.
4. Press PRESET +/- on the Remote Control to select the preset number you want.
5. Press PROG/MEMO on the Remote Control again.
The station is stored.
6. Repeat steps 3 to 6 to store other stations.

To tune in a station with a weak signal

Press TUN.(-/+) repeatedly in step 3 to tune in the station manually.

To clear all the stored stations

Press and hold PROG/MEMO for about two seconds and "ERASE ALL" is appeared in the display window and then press PROG/MEMO again, the stations are cleared.

- If you have accidentally entered into the "ERASE ALL" mode and you do not wish to clear the memory, do not press any key. After a few seconds, the "ERASE ALL" display will go off by itself and change to normal mode.

Note:

If all stations have already been entered, the FULL message will appear in the display window for a moment and then a preset number will flash. To change the preset number, follow the steps 5-6 as above.

Listening to the Radio

Preset radio stations in the unit memory first (see "Presetting radio stations" on the left).

1. Press BAND until FM or AM appears in the display window.
The last received station is tuned in.
2. Press PRESET +/- repeatedly on the Remote Control to select the preset station you want.
Each time you press the button, the unit tunes in one preset station at a time.
3. Adjust the volume by rotating VOLUME on the front panel or by pressing VOLUME + or - on the Remote Control repeatedly.

To turn off the radio

Press POWER to turn the unit off or select another function mode (DVD/CD, AV 1, etc.,).

To listen to non-preset radio stations

- Use manual or automatic tuning in step 2.
- For manual tuning, press TUN.(-/+) repeatedly.
- For automatic tuning, press and hold TUN.(-/+) for about two seconds on the front panel.

To select a preset radio station directly

You can use the number buttons on the Remote Control to select a preset radio station directly. For example, to listen to preset station 4, press 4 on the Remote Control. To listen to preset station 19, press 1 then 9 (within 3 seconds).

XM Satellite Radio Operation

What is XM Satellite Radio?

XM Radio is the satellite radio service with millions of listeners across the U.S.

Broadcasting live daily, XM Radio offers 160 digital radio channels offering music, news, sports, comedy, talk, entertainment, traffic and weather reports, with high quality digital sound.

XM service subscription sold separately. XM Passport System required to receive XM service (sold separately). Installation costs and other fees and taxes, including a one-time activation fee may apply. XM service only available in the 48 contiguous United States. Residents in Canada please see information about Canadian Satellite Radio at the following webpage: (www.cdnsatrad.com). XM Connect-and-Play is a trademark of XM Satellite Radio Inc. ©2006 XM Satellite Radio Inc. All rights reserved.

What is XM Ready?

An audio system labeled "XM Ready" means that the system with the addition of an XM Passport Antenna has everything you need to play XM. Everything else is built inside.

XM Satellite Radio connections

- Connect the XM Digital Antenna to the XM passport system on the unit.

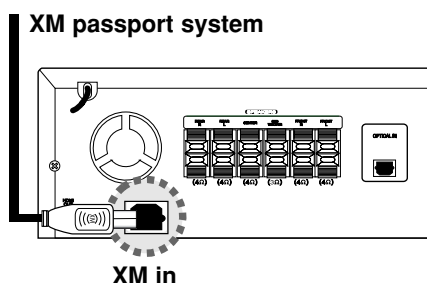

Activating Your Service

A one-time activation fee is required to establish an account and activate service with XM Satellite Radio. Applicable activation changers will be added to your first bill.

1. Before activating XM service, make sure your XM equipment is tuned to the XM Preview Channel (Channel 1).
2. Determine your eight-character XM Satellite Radio ID number by referencing the label on your XM Passport System packaging, rear cover, or by selecting channel 0. The ID number will appear on the display.

Note:

Carefully check your XM Satellite Radio ID. The letter I, O, S, and F are not used

3. Activate your XM Satellite Radio service. Make sure you have a major credit card and your XM Satellite Radio ID number handy.

To activate via the internet: Visit

<http://www.xmradio.com/activation>

To activate via phone: Call 1-800-XM-RADIO (967-2346)

A one-time activation fee will apply.

Selecting the XM Satellite Radio

Press Band to select XM band.

XM information

When receiving the XM Satellite Radio containing, you can see the information in the display window.

Press XM Mode to change XM display mode.

Channel Number → Channel Label →
Song Name/Artist Name → Signal Strength →
Channel Number → ...

• Channel Number :

Display current XM Channel Number

Channel Number shows 3 seconds regardless its display mode when channel is changed.

When user edits or change preset, it works on channel number display mode

• Channel Label

Display name of current channel.

• Song Name & Artist Name

Display song name & artist name as scroll.

• Signal Strength

Signal Strength is showed by 3 bars with antenna shape.

No Bar : No Signal.

One Bar : Weak Signal

Two Bar : Marginal Signal

Three Bar : Good Signal

Presetting the XM Satellite Radio Stations

You can preset 50 stations for XM. Before tuning, make sure that you have turned down the volume.

1. Press Band to select XM band.
2. Use XM CH - or XM CH + on the Remote Control to select the desired channel.
3. Press PROG/MEMO. on the Remote Control.
4. Press PRESET ▲ or ▼ on the Remote Control to select the preset number you want.
5. Press PROG/MEMO. on the Remote Control again.
The station is stored.
6. Repeat steps 2 to 5 to store other stations.

To clear all the stored stations

Press and hold PROG/MEMO. for about two seconds and "ERASE ALL" is shown in the display window and then press PROG/MEMO. again, the stations are cleared.

- If you have accidentally entered into the "ERASE XM" mode and you do not wish to clear the memory, do not press any key. After a few seconds, the "ERASE XM" display will go off by itself and change to normal mode.

Channel Selection

Preset Search

Use ▲/▼ on the Remote Control repeatedly to select the preset station you want.

Direct Tuning

1. Using Numeric button on Remote Control, select channel number directly.
2. Press ENTER after more than one numeric key input, system moves to new channel immediately.

Channel up/down

Use XM CH - or XM CH + repeatedly to select the channel you want.

Category Search

1. Select the Category Search mode using the CAT key on the Remote Control.
(CAT Icon Blinking in Category Search mode.)
2. ▲/▼ changes target of category for search, XM CH - or XM CH + selects next channel of selected category in category search mode

Note:

Category type of current channel displays for 3 seconds when category key is inputted in not category display mode

Category search mode is released below case.

- CAT is inputted in Category search mode.
- No input of ▲/▼, XM CH - or XM CH + key for 15 seconds.

Advisory Message

ANTENNA	XM Passport System is not connected • Check the connection of XM Passport System
SVC ANT	XM Passport System does not work properly • Need service of XM Passport System
UPDATING	XM Passport System is not activated, or User does not have authorization for specific channel • Subscribe activation of XM Passport System
NO SIGNAL	Receiving signal is too weak • XM Passport System to south window for best reception
OFF AIR	Selected channel is not broadcasting currently. • Check programming list, select another channel.
LOADING	XM Passport System is now decoding channel. • Wait completion of decoding process
XM---	Selected channel is not available. • Check programming list, select another channel.
----- ----/---- -----	Channel label or Song name/Artist name or Category name is not available

Controlling your TV with the Supplied Remote Control

You can control the sound level, input source, and power switch of your LG TV with the supplied Remote Control.

You can control your TV using the buttons below.

By pressing	You can
TV POWER	Turn the TV on or off.
CHANNEL(▲ / ▼)	Scans up or down through memorized channels.
VOLUME +/-	Adjust the volume of the TV.
TV INPUT	Switch the TV's input source between the TV and other input sources.
MUTE	Turns on or off TV sound.

Note:

Depending on the unit being connected, you may not be able to control your TV using some of the buttons.

Controlling other TVs with the Supplied Remote Control

You can control the sound level, input source, and power switch of non-LG TVs as well. If your TV is listed in the table below, set the appropriate manufacturer code. (refer to 35 page)

1. While holding down TV POWER button, press the number buttons to select the manufacturer code for your TV (Refer to table on the right column).
2. Release TV POWER button.

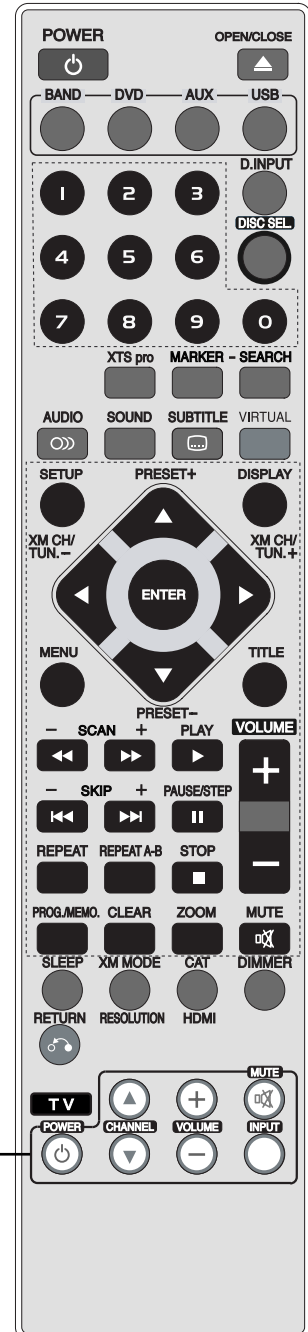

TV Control Buttons

Controlling Your TV with the Supplied Remote Control (Continued)

If more than one code number is listed, try entering them one at a time until you find the one that works with your TV.

Manufacturer	Code Number	Manufacturer	Code Number
ADMIRAL	16,33,37,44,45	MONTGOMERY	01,06,08,09
AIWA	70	WARD	23,24,32,33,34
AKAI	01	NEC	01,08
AMARK	09	NOBLEX	07
AOC	01	PACKARD BELL	43
BELL & HOWELL	33	PANASONIC	07,11,13,25,35,36
BROKSONIC	18,19	PHILCO	01,06,07,08,09, 15,38,43,58
CANDLE	51	PHILIPS	06,07,43,61,62,65
CCE	07	PIONEER	30
CENTURION	08	PORTLAND	09
CINERAL	43	PROSCAN	03,37,44
CITIZEN	49,50,51,52,53,54,55	QUASAR	11,13
CORONADO	09	RADIO SHACK	16,17,23
CROWN	09	RCA	01,03,37,44,69
CURTIS MATHES	01,03,08,33,35,37,44	REALISTIC	16,17,23
DAEWOO	16,38,39,40,41,42,43	SAMPO	08
DAYTRON	01,08	SAMSUNG	01,08,09,25,68
EMERSON	01,09,16,17,18,19	SANYO	28,29
FISHER	28,29	SCOTT	01,08
FUNAI	46,47	SEARS	09,25,26,27,28,29
GENERAL ELECTRIC	03,10,11,13,37,44	SEMP	64
GRADIENTE	01,56,57,63,67	SHARP	09,22,23,24,60,66
HITACHI	09,14,15,43	SIGNATURE 2000	01,06,08,09,10, 23,24,33,34
JC PENNEY	01,08,10,27,35	SONY	12,62
JVC	20,21,63,67	SOUNDESIGN	51
KIOTE	43	SYLVANIA	01,04,05,06,07, 08,35,51
KMC	09	SYMPHONIC	46,47
KTV	01,08,09,31	TATUNG	11
LG (GOLDSTAR)	01,07,08,09,35,39,40	TEKNIKA	07,09,16,33,51
LODGENET	33	TELERENT	09,33
LOGIK	33	THOMSON	69
LXI	09,24,25,26,27,28,29	YORX	08
MAGNAVOX	01,02,04,05,06, 07,08,09,20, 34,35,43,51,61,62,65	TOSHIBA	01,25,26,27,64
MAJESTIC	33	WARDS	01,06,08,09,10,33,34
MARANTZ	01,32	XR1000	48
MEMOREX	33	ZENITH	01,02,33,59
MGA/MITSUBISHI	01,08,32,34		

Notes:

- Depending on your TV, some or all buttons may not function on the TV, even after entering the correct manufacturer code.
- If you enter a new code number, the code number previously entered will be erased.
- When you replace the batteries of the remote, the code number you have set may be reset to the default setting. Set the appropriate code number again.

Language Codes

Use this list to input your desired language for the following initial settings:
Disc Audio, Disc Subtitle, Disc Menu.

Language	Code	Language	Code	Language	Code	Language	Code
Abkhazian	6566	Fiji	7074	Lingala	7678	Singhalese	8373
Afar	6565	Finnish	7073	Lithuanian	7684	Slovak	8375
Afrikaans	6570	French	7082	Macedonian	7775	Slovenian	8376
Albanian	8381	Galician	7176	Malagasy	7771	Somali	8379
Ameharic	6577	Georgian	7565	Malay	7783	Spanish	6983
Arabic	6582	German	6869	Malayalam	7776	Sudanese	8385
Armenian	7289	Greek	6976	Maltese	7784	Swahili	8387
Assamese	6583	Greenlandic	7576	Maori	7773	Swedish	8386
Azerbaijani	6590	Guarani	7178	Marathi	7782	Tagalog	8476
Bashkir	6665	Gujarati	7185	Moldavian	7779	Tajik	8471
Basque	6985	Hausa	7265	Mongolian	7778	Tamil	8465
Bengali; Bangla	6678	Hebrew	7387	Nauru	7865	Tatar	8484
Bhutani	6890	Hindi	7273	Nepali	7869	Telugu	8469
Bihari	6672	Hungarian	7285	Norwegian	7879	Thai	8472
Breton	6682	Icelandic	7383	Oriya	7982	Tibetan	6679
Bulgarian	6671	Indonesian	7378	Panjabi	8065	Tigrinya	8473
Burmese	7789	Interlingua	7365	Pashto, Pushto	8083	Tonga	8479
Byelorussian	6669	Irish	7165	Persian	7065	Turkish	8482
Cambodian	7577	Italian	7384	Polish	8076	Turkmen	8475
Catalan	6765	Japanese	7465	Portuguese	8084	Twi	8487
Chinese	9072	Javanese	7487	Quechua	8185	Ukrainian	8575
Corsican	6779	Kannada	7578	Rhaeto-Romance	8277	Urdu	8582
Croatian	7282	Kashmiri	7583	Rumanian	8279	Uzbek	8590
Czech	6783	Kazakh	7575	Russian	8285	Vietnamese	8673
Danish	6865	Kirghiz	7589	Samoan	8377	Volapük	8679
Dutch	7876	Korean	7579	Sanskrit	8365	Welsh	6789
English	6978	Kurdish	7585	Scots Gaelic	7168	Wolof	8779
Esperanto	6979	Laothian	7679	Serbian	8382	Xhosa	8872
Estonian	6984	Latin	7665	Serbo-Croatian	8372	Yiddish	7473
Faroese	7079	Latvian, Lettish	7686	Shona	8378	Yoruba	8979
				Sindhi	8368	Zulu	9085

Area Codes

Choose a country code from this list.

Country	Code	Country	Code	Country	Code	Country	Code
Afghanistan	AF	Ethiopia	ET	Malaysia	MY	Saudi Arabia	SA
Argentina	AR	Fiji	FJ	Maldives	MV	Senegal	SN
Australia	AU	Finland	FI	Mexico	MX	Singapore	SG
Austria	AT	France	FR	Monaco	MC	Slovak Republic	SK
Belgium	BE	Germany	DE	Mongolia	MN	Slovenia	SI
Bhutan	BT	Great Britain	GB	Morocco	MA	South Africa	ZA
Bolivia	BO	Greece	GR	Nepal	NP	South Korea	KR
Brazil	BR	Greenland	GL	Netherlands	NL	Spain	ES
Cambodia	KH	Islands	HM	Netherlands Antilles	AN	Sri Lanka	LK
Canada	CA	Hong Kong	HK	New Zealand	NZ	Sweden	SE
Chile	CL	Hungary	HU	Nigeria	NG	Switzerland	CH
China	CN	India	IN	Norway	NO	Taiwan	TW
Colombia	CO	Indonesia	ID	Oman	OM	Thailand	TH
Congo	CG	Israel	IL	Pakistan	PK	Turkey	TR
Costa Rica	CR	Italy	IT	Panama	PA	Uganda	UG
Croatia	HR	Jamaica	JM	Paraguay	PY	Ukraine	UA
Czech Republic	CZ	Japan	JP	Philippines	PH	United States	US
Denmark	DK	Kenya	KE	Poland	PL	Uruguay	UY
Ecuador	EC	Kuwait	KW	Portugal	PT	Uzbekistan	UZ
Egypt	EG	Libya	LY	Romania	RO	Vietnam	VN
El Salvador	SV	Luxembourg	LU	Russian Federation	RU	Zimbabwe	ZW

Troubleshooting

Check the following guide for the possible cause of a problem before contacting service.

Symptom	Cause	Correction
No power.	<ul style="list-style-type: none"> The power cord is disconnected. 	<ul style="list-style-type: none"> Plug the power cord securely into the wall outlet.
The power is on, but the DVD/CD Receiver does not work.	<ul style="list-style-type: none"> No disc is inserted. 	<ul style="list-style-type: none"> Insert a disc. (Check that the DVD or, audio CD indicator in the DVD display is lit.)
No picture. The resolution (720p, 1080i) does not work with the analog video connections (VIDEO OUT & S-VIDEO)	<ul style="list-style-type: none"> The TV is not set to receive DVD signal output. 	<ul style="list-style-type: none"> Select the appropriate video input mode on the TV so the picture from the DVD/CD Receiver appears on the TV screen.
	<ul style="list-style-type: none"> The video cable is not connected securely. 	<ul style="list-style-type: none"> Connect the video cable into the jacks securely.
	<ul style="list-style-type: none"> The connected TV power is turned off. 	<ul style="list-style-type: none"> Turn on the TV.
There is no sound or only a very low-level sound is heard.	<ul style="list-style-type: none"> The equipment connected with the audio cable is not set to receive DVD signal output. 	<ul style="list-style-type: none"> Select the correct input mode of the audio receiver so you can hear the sound from the DVD/CD Receiver.
	<ul style="list-style-type: none"> The audio cables are not connected securely. 	<ul style="list-style-type: none"> Connect the audio cable into the jacks securely.
	<ul style="list-style-type: none"> The power of the equipment connected with the audio cable is turned off. 	<ul style="list-style-type: none"> Turn on the equipment connected with the audio cable.
	<ul style="list-style-type: none"> The audio connecting cable is damaged. 	<ul style="list-style-type: none"> Replace it with new one.
The playback picture is poor.	<ul style="list-style-type: none"> The disc is dirty. 	<ul style="list-style-type: none"> Clean the disc.
The DVD/CD Receiver does not start playback.	<ul style="list-style-type: none"> No disc is inserted. 	<ul style="list-style-type: none"> Insert a disc. (Check that the DVD, or audio CD indicator in the DVD display is lit.)
	<ul style="list-style-type: none"> An unplayable disc is inserted. 	<ul style="list-style-type: none"> Insert a playable disc. (Check the disc type, colour system and Regional code.)
	<ul style="list-style-type: none"> The disc is placed upside down. 	<ul style="list-style-type: none"> Place the disc with the playback side down.
	<ul style="list-style-type: none"> The disc is not placed within the guide. 	<ul style="list-style-type: none"> Place the disc on the disc tray correctly inside the guide.
	<ul style="list-style-type: none"> The disc is dirty. 	<ul style="list-style-type: none"> Clean the disc.
	<ul style="list-style-type: none"> A menu is on the TV screen. 	<ul style="list-style-type: none"> Press the SETUP button to turn off the menu screen.
	<ul style="list-style-type: none"> The Rating level is set. 	<ul style="list-style-type: none"> Cancel the Rating function or change the rating level.
Loud hum or noise is heard.	<ul style="list-style-type: none"> The disc is dirty. 	<ul style="list-style-type: none"> Clean the disc.
	<ul style="list-style-type: none"> The speakers and components are connected poorly. 	<ul style="list-style-type: none"> Connect the speakers and components securely.
	<ul style="list-style-type: none"> The DVD/CD Receiver is located too close to the TV. 	<ul style="list-style-type: none"> Move your TV away from the audio components.

Symptom	Cause	Correction
Radio stations cannot be tuned in.	<ul style="list-style-type: none"> The antenna is positioned or connected poorly. 	<ul style="list-style-type: none"> Connect the antenna securely. Adjust the antennas and connect an external antenna if necessary.
	<ul style="list-style-type: none"> The signal strength of the stations is too weak (when tuning in with automatic tuning). 	<ul style="list-style-type: none"> Tune in the station manually.
	<ul style="list-style-type: none"> No stations have been preset or preset stations have been cleared (when tuning by scanning preset stations). 	<ul style="list-style-type: none"> Preset the stations (page 31).
The Remote Control does not work properly.	<ul style="list-style-type: none"> The Remote Control is not pointed at the remote sensor of the unit. 	<ul style="list-style-type: none"> Point the Remote Control at the remote sensor of the unit.
	<ul style="list-style-type: none"> The Remote Control is too far from the unit. 	<ul style="list-style-type: none"> Use the Remote Control within about 20 ft (6 m).
	<ul style="list-style-type: none"> There is an obstacle in the path of the Remote Control and the unit. 	<ul style="list-style-type: none"> Remove the obstacle.
	<ul style="list-style-type: none"> The batteries in the Remote Control are flat. 	<ul style="list-style-type: none"> Replace the batteries with new ones.
The front panel display is too dim.	<ul style="list-style-type: none"> Nothing is displayed on the front panel display. 	<ul style="list-style-type: none"> Press DIMMER on the Remote Control.

Maintenance and Service

Refer to the information in this chapter before contacting a service technician.

HANDLING THE UNIT

When shipping the unit

Please save the original shipping carton and packing materials. If you need to ship the unit, for maximum protection, re-pack the unit as it was originally packed at the factory.

Keeping the exterior surfaces clean

- Do not use volatile liquids such as insecticide spray near the unit.
- Do not leave rubber or plastic products in contact with the unit for a long period of time. since they leave marks on the surface.

Cleaning the unit

To clean the unit, use a soft, dry cloth. If the surfaces are extremely dirty, use a soft cloth lightly moistened with a mild detergent solution.

Do not use strong solvents such as alcohol, benzene, or thinner, as these might damage the surface of the unit.

Maintaining the Unit

The unit is a high-tech, precision device. If the optical pick-up lens and disc drive parts are dirty or worn, the picture quality could be diminished.

Depending on the operating environment, regular inspection and maintenance are recommended after every 1,000 hours of use.

For details, please contact your nearest authorized service center.

Specifications

General	Power supply	Refer to main label			
	Power consumption	Refer to main label			
	Mass	5.5 kg			
	External dimensions (W x H x D)	430 x 93 x 350 mm			
	Operating conditions	Temperature: 5°C to 35°C, Operation status: Horizontal			
	Operating humidity	5% to 85%			
CD/DVD	Laser	Semiconductor laser, wavelength 650 nm			
	Signal system	NTSC 525/60			
	Frequency response (audio)	150 Hz to 18 kHz			
	Signal-to-noise ratio (audio)	More than 75 dB (1 kHz, NOP -6 dB, 20 kHz LPF/A-Filter)			
	Dynamic range (audio)	More than 70 dB			
	Harmonic distortion (audio)	0.5 % (1 kHz, at 1W position) (20 kHz LPF)			
Video	Video input	1.0 V (p-p), 75 Ω, negative sync., RCA jack x 2			
	Video output	1.0 V (p-p), 75 Ω, negative sync., RCA jack x 1			
	S-video output	(Y) 1.0 V (p-p), 75 Ω, negative sync., Mini DIN 4-pin x 1 (C) 0.3 V (p-p), 75 Ω			
	COMPONENT VIDEO OUT	(Y) 1.0 V (p-p), 75 ohms, negative sync, RCA jack x 1 (Pb)/(Pr) 0.7 V (p-p), 75 ohms, RCA jack x 2			
Tuner	FM	Tuning Range	87.5 - 108.0 MHz		
		Intermediate Frequency	10.7 MHz		
Signal-to Noise Ratio		60 dB (Mono)			
Frequency Response		150 - 8,000 Hz			
AM	Tuning Range	522 - 1,620 kHz or 520 - 1,720 kHz			
	Intermediate Frequency	450 kHz			
Amplifier	Stereo mode	155W + 155W (Rated Output Power 130W, 4Ω at 1 kHz, THD 10 %)			
	Surround mode	Front: 155W + 155W (Rated Output Power 130W, THD 10 %) Centre*: 155W Surround*: 155W + 155W (Rated Output Power 130W, 4Ω at 1 kHz, THD 10 %) Subwoofer*: 225W (Rated Output Power 180W, 3Ω at 30 Hz, THD 10 %)			
	(* Depending on the sound mode settings and the source, there may be no sound output.)				
	Inputs	VIDEO 1, VIDEO 2, COAXIAL AUDIO, OPTICAL AUDIO			
	Outputs	S-VIDEO, MONITOR, PHONES: (32 Ω, 1.0 V)			
Speakers		Front Speaker (LHS-96PAF)	Rear Speake (LHS-96PAS)	Center speaker (LHS-96PAC)	Woofe Speaker (LHS-96PAW)
	Type	2 Way 3 Speaker	1 Way 1 Speaker	2 Way 3 Speaker	1 Way 1 Speaker
	Impedance	4 Ω	4 Ω	4 Ω	3 Ω
	Frequency Response	90 - 18,000 Hz	120 - 20,000 Hz	80 - 18,000 Hz	40 - 1,500Hz
	Sound Pressure Level	836 dB/W (1m)	82 dB/W (1m)	86 dB/W (1m)	82 dB/W (1m)
	Rated Input Power	155 W	155 W	155 W	225 W
	Max. Input Power	310 W	310 W	310 W	450 W
	Net Dimensions (W x H x D)	300x1350x300mm	120x248x96mm	500x160x155mm	236x435x391mm
	Net Weight	5.35kg	0.87kg	1.73kg	10.5kg



**LG Electronics, Inc.
Home Theater System -LH-E9670
Limited Warranty - USA**

This LG Electronics product, will be repaired or replaced, at LG's option, if it proves to be defective in material or workmanship, under normal use, during the warranty period ("Warranty Period") listed below, effective from the date ("Date of Purchase") of original consumer purchase of the product. This warranty is good only to the original purchaser of the product and effective only when used in the United States, excluding U.S. Territories.

WARRANTY PERIOD: LABOR: 90 days from the Date of Purchase. PARTS: One Year from the Date of Purchase. * Parts replaced are warranted for the remaining portion of the original warranty period.	HOW SERVICE IS HANDLED: Call 1-800-243-0000 for instructions on getting the defective unit repaired or replaced. Please retain dated sales receipt and your box to return the unit to LG for repair or replacement. Shipping both ways will be paid by LG during the first 90 days of the Warranty Period. During the remainder of the Warranty Period (91-365 days), you pay inbound shipping charges and LG pays return shipping charges. Visit our website at: http://www.lgservice.com
---	--

THIS WARRANTY IS IN LIEU OF ANY OTHER WARRANTIES, EXPRESS OR IMPLIED, INCLUDING WITHOUT LIMITATION, ANY WARRANTY OF MERCHANTABILITY OR FITNESS FOR A PARTICULAR PURPOSE. TO THE EXTENT ANY IMPLIED WARRANTY IS REQUIRED BY LAW, IT IS LIMITED IN DURATION TO THE EXPRESS WARRANTY PERIOD ABOVE. LG ELECTRONICS WILL NOT BE LIABLE FOR ANY INCIDENTAL, CONSEQUENTIAL, INDIRECT, SPECIAL OR PUNITIVE DAMAGES OF ANY NATURE, EVEN IF ADVISED OF THE POSSIBILITY OF SUCH DAMAGES, INCLUDING WITHOUT LIMITATION, LOST REVENUES OR PROFITS, LOST OR CORRUPTED PROGRAMMING OR DATA, OR ANY OTHER DAMAGE WHETHER BASED IN CONTRACT, TORT OR OTHERWISE. Some states do not allow the exclusion or limitation of incidental or consequential damages or limitation on how long an implied warranty lasts, so the above exclusion or limitation may not apply to you. This warranty gives you specific legal rights and you may also have other rights that may vary from state to state.

THIS LIMITED WARRANTY DOES NOT APPLY TO:

- Damages or operating problems that result from shipping, installation, adjustment of user controls, calibration, maintenance or failure to maintain, or separate system components; and
- Damages or operating problems that result from normal wear and tear, misuse, abuse, operation outside environmental specifications or contrary to the requirements or precautions in the Operating Guide, accident, lightning strikes or other natural causes, unauthorized modification or alteration, incorrect electrical current or voltage, reception problem caused by inadequate home antenna or faulty antenna connections, computer software, institutional or commercial use, or other causes not arising out of defect in material or workmanship.

Therefore, the cost of repair or replacement of such defective product shall be borne by the consumer.

CUSTOMER INTER-ACTIVE CENTER NUMBERS:

For nearest Authorized Service Center, Where to buy, Product Assistance, or Customer Assistance	Call 1-800-243-0000 (24 hours a day, 365 days per year) and select appropriate options from the menu. Or visit our website at http://www.lgservice.com
--	---